

# DVP-SX

## Multi-function, Built-in Analog I/O, Multiple Commands PLC Instruction Sheet

### 1 WARNING

This Instruction Sheet only provides descriptions for electrical specifications, general specifications, installation & wiring, troubleshooting and peripherals. Other detail information about programming and commands is compatible with SA/SC/SX series; please see PLC Application Manual. For more information about the optional peripherals, please see individual product manual.

This is an OPEN TYPE PLC. The PLC should be kept in an enclosure away from airborne dust, humidity, electric shock risk and vibration. Also, it is equipped with protective methods such as some special tools or keys to open the enclosure, so as to avoid the hazard to users and the damage to the PLC.

Never connect the AC main circuit power supply to any of the input/output terminals, as it will damage the PLC. Check all the wiring prior to power up. To avoid any electromagnetic noise, make sure the PLC is properly grounded. Do NOT touch terminals when power on.

### 2 INTRODUCTION

#### 2.1 Model Name Explanation and Peripherals

Thank you for choosing DELTA's PLC DVP series. The DVP-SX series is a 10-point (4DI+2DO+2AI+2AO) special main processing unit. Besides the same commands and functions as DVP-SA/SX/SC series, 2-CH 12-bit analog voltage/current input and 2-CH 12-bit analog voltage/current output are all bipolar.

There is built-in 2-digit 7-segment display corresponds to internal register directly to display PLC station or user-defined code.

#### Model Name

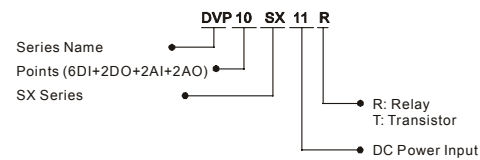

#### Nameplate Explanation

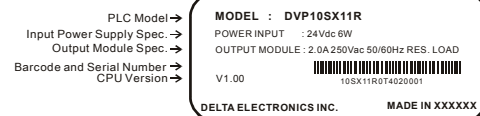

#### Serial Number

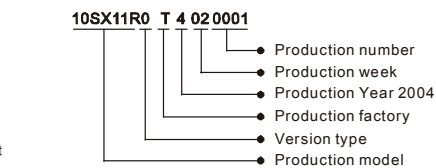

#### Peripherals

- ◎ DVPHPP02: Handheld Programming panel
- ◎ WPLSoft: Windows Ladder Logic Programming Software
- ◎ DVPACAB115: 1.5M Cable (HPP ↔ PLC, included in DVPHPP02)
- ◎ DVPACAB215: 1.5M Cable (PC (DB9+DB25) ↔ PLC)
- ◎ DVPACAB230: 3.0M Cable (PC (DB9+DB25) ↔ PLC)
- ◎ DVPACAB2A30: 3.0M Cable (PC (DB9) ↔ PLC)

#### 2.2 Product Profile and Outline

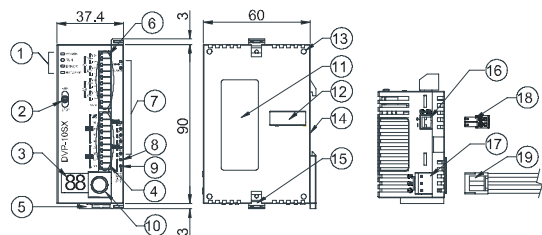

Units: mm

- Status indicator: POWER, RUN, ERROR, BAT.LOW
- RUN/STOP switch
- 2-digital 7-segment display
- Digital I/O terminal
- DIN rail clip
- Analog I/O terminals
- I/O point indicators
- COM1 (RS-232) (Rx) indicator
- COM2 (RS-485) (Tx) indicator
- COM1 (RS-232) Communication port (Slave)
- Nameplate
- Expansion port
- Mounting hold of the expansion unit
- DIN rail (35mm)
- Expansion unit clip
- COM2 (RS-485) Communication port
- DC Power input

※ Battery replacement: Please change the battery within 3 minutes, or the internal data of the PLC (including the program area, RTC and latched registers) could be lost or destroyed.

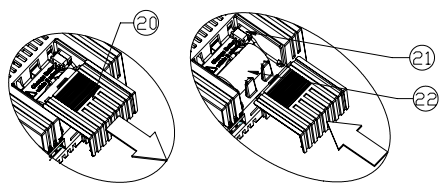

18	2 pin removable terminal (standard accessory)	21	Battery socket connection
19	Power input cable (standard accessory)	22	Battery mount
20	Battery Cover		

### 3 FUNCTION SPECIFICATIONS

Items	Specifications	Remarks
Control Method	Stored program, cyclic scan system	
I/O Processing Method	Batch processing method (when END command is executed)	I/O refresh command is available
Execution Speed	Basic commands (several us)	Application Commands (10~hundreds us)
Program language	Commands + Ladder Logic + SFC	Including the Step commands
Program Capacity	7920 STEPS	SRAM + Battery
Commands	32 Basic sequential commands (including STL/RET)	168 Application commands
X External input relay	X0~X177, octal number system, 128 points	Total 256 points Correspond to external input point
Y External output relay	Y0~Y177, octal number system, 128 points	Total 256 points Correspond to external output point
M Auxiliary Relay	General: M0~M511, 512 points (*1) Latched: M512~M999, 488 points (*3) Special: M2000~M4095, 2096 points (*3) M1000~M1999, 1000 points (some are latched)	Total 4096 points Contacts can switch to On/Off in program
T Timer	T0~T199, 200 points (*1) T192~T199 for Subroutine T250~T255, 6 points Accumulative (*4) T200~T239, 40 points (*2) T240~T245, 6 points Accumulative (*4) T246~T249, 4 points Accumulative (*4)	Total 256 points When the timer that set by TMR command reaches the preset value, the T contact with the same number will be On.
C Counter	16-bit count up: C0~C95, 96 points (*1) 32-bit count up/down: C96~C199, 104 points (*3) 32-bit high-speed count up/down: C200~C215, 16 points (*1) C216~C234, 19 points (*3) C235~C245, 1 phase 1 input, 9 points (*3) C246~C250, 1 phase 2 inputs, 3 points (*3) C251~C254, 2 phase 2 inputs, 3 points (*3)	Total 250 points When the counter that set by CNT (DCNT) command reaches the preset value, the C contact with the same number will be On.
S Step point	Initial step point: S0~S9, 10 points (*1) Zero point reset: S10~S19, 10 points (use with IST command) (*1) General: S20~S511, 492 points (*1) Latched: S512~S895, 384 points (*3) Alarm: S896~S1023, 124 points (*3)	Total 1024 points Usage device of step ladder diagram (SFC) Latched Range: Start: D1214 (K512) End: D1215 (K895)
T Current value of the timer	T0~T255, 256 points	When the timer reaches the preset value, the contact of timer will be On.
C Current value of the counter	C0~C199, 16-bit counter, 200 points C200~C254, 32-bit counter, 50 points	When the counter reaches the preset value, the contact of counter will be On.
D Data register	General: D0~D199, 200 points (*1) Latched: D200~D999, 800 points (*3) Special: D2000~D4999, 3000 points (*3) Index: D1000~D1999, 1000 points E0~E3, F0~F3, 8 points (*1)	Total 5000 points Can be memory area for storing data. E and F can be used as the special purpose of index indication.
None File register	0~1599 (1600 points) (*4)	Expansion register for storing data.
N For master control nested loop	N0~N7, 8 points	Control point of master control nested loop
P For CJ_CALL commands	P0~P255, 256 points	The location point of CJ_CALL.
I Interrupt Service	External interrupt: I001 (X0), I101 (X1), I201 (X2), I301 (X3), I401 (X4), I501 (X5); 6 points (all are rising-edge trigger) Time interrupt: I6□□ (1ms), I7□□ (1ms), (□□ = 1~99ms) Hi-speed counter: I010, I020, I030, I040, I050, I060; 6 points Communication: I150, 1 point	The location pointer of interrupt subroutine
K Decimal	K-32,768 ~ K32,767 (16-bit operation) K-2,147,483,648 ~ K2,147,483,647 (32-bit operation)	
H Hexadecimal	H0000 ~ HFFFFF (16-bit operation), H00000000 ~ HFFFFFFF (32-bit operation)	
Programming port	COM1: RS-232, COM2: RS-485 (Master/Slave). They can be used at the same time.	
Analog Volume / RTC	MPU built-in bipolar 2-CH A/D, D/A, 12 bits, 2-digital 7-segment display, built-in RTC	
Special Expansion Module	Use the same modules (AD, DA, PT, TC, XA, RT) of SS series. (Max. 8 Expansion Unit points)	

- \*1: The non-latched area is fixed, and can't be changed.
- \*2: The non-latched area can be changed to a latched area with parameter setting.
- \*3: The latched area can be changed to a non-latched area with parameter setting.
- \*4: The latched area is fixed, and can't be changed.

M Auxiliary Relay	General	Latched	Special auxiliary relay	Latched
	M0~M511	M512~M999	M1000~M1999	M2000~M4095
	Non-latched (fixed)	Latched (default) Start: D1200 (K512) End: D1201 (K999)	Some are latched and can't be changed	Latched (default) Start: D1202 (K2000) End: D1203 (K4095)
T Timer	100 ms T0~T199	10 ms T200~T239	10ms T240~T245	1 ms T246~T249 100 ms T250~T255
	Non-latched (fixed)	Non-latched (fixed)	Accumulative Latched (fixed)	
C Counter	16-bit count up		32-bit count up/down	
	C0~C95	C96~C199	C200~C215	C216~C234 C235~C245 C246~C255
	Non-latched (fixed)	Latched (default) Start: D1208 (K96) End: D1209 (K199)	Non-latched (fixed)	Latched (default) Start: D1210 (K216) End: D1211 (K234) Latched (default) Start: D1212 (K235) End: D1213 (K255)
S Step relay	For general: S0~S9 Latched: S10~S19	Special register: S20~S511	Latched: S512~S895 Factory setting is latched Start: D1214 (K512) End: D1215 (K895)	For general: S896~S1023
	It is fixed to be non-latched		It is fixed to be latched	
D Register	General: D0~D199	Latched: D200~D999 Factory setting is latched. Start: D1216 (K200) End: D1217 (K999)	Special registers: D1000~D1999	Latched: D2000~D4999 Factory setting is latched. Start: D1218 (K2000) End: D1219 (K4999)
File Register	K0~K1599, Latched (fixed)			

※ When switching between power On/Off or MPU RUN/STOP modes:

Memory Type	POWER Off→On	STOP→RUN	RUN→STOP	Clear all M1031 non-latched area	Clear all M1032 latched area	Factory Setting
Non-latched	Clear	Unchanged	M1033=Off, clear M103=On, unchanged	Clear	Unchanged	0
Latched		Unchanged		Unchanged	Clear	0
Special M, Special D, Index register	Initial value	Unchanged		Unchanged		Initial value
File register				Unchanged		0

### 4 BUILT-IN ANALOG I/O AND 7-SEGMENT DISPLAY

Built-in 2-CH 12-bit A/D and 2-CH 12-bit D/A are bipolar. It can read A/D converted digital value and get designated analog output by reading special D or writing into special D. Refer following table for corresponding special D.

Device No.	Function
D1056	Present value of AD card channel 0 (CH0)
D1057	Present value of AD card channel 1 (CH1)
D1110	Average value of AD card channel 0 (CH0)
D1111	Average value of AD card channel 1 (CH1)
D1116	DA card channel 0 (CH0)
D1117	DA card channel 1 (CH1)
D1118	Conversion sampling time (ms)

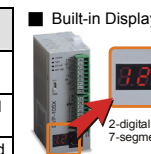

This built-in display corresponds to special D directly. User can use it to display error code or station when executing PLC LINK. It is great convenience for system maintenance. Refer following table for corresponding special D.

Device No.	Function
M1196	Number system setting for display (Off: Decimal, On: Hexadecimal)
M1197	The decimal point setting between the middle and the right-most numbers
M1198	The decimal point setting after the right-most number
D1196	Display content

### 5 ELECTRICAL SPECIFICATIONS

Item	Model	DVP10SX11R/T	DVP08SM11N	DVP08SN11R/T	DVP08SP11R/T	DVP16SP11R/T
Power supply voltage		MPU: 24VDC (-15%~20%) (with DC input reverse polarity protection), Expansion Unit: supplied by the MPU				
Fuse		2A / 250VAC				
Power Consumption		5W	1W	1.5W	1.5W	2W
Insulation Resistance		> 5 MΩ at 500 VDC (Between all inputs / outputs and earth)				
Noise Immunity		ESD: 8KV Air Discharge EFT: Power Line: 2KV, Digital I/O: 1KV, Analog & Communication I/O: 250V Damped-Oscillatory Wave: Power Line: 1KV, Digital I/O: 1KV RS: 26MHz~1GHz, 10V/m				
Grounding		The diameter of grounding wire cannot be smaller than the wire diameter of terminals L and N (All DVP units should be grounded directly to the ground pole).				
Environment		Operation: 0°C~55°C (Temperature), 50~95% (Humidity), Pollution degree 2; Storage: -25°C~70°C (Temperature), 5~95% (Humidity); D/A output operation: 0°C~50°C (Temperature)				
Vibration / Shock Resistance		Standard: IEC1131-2, IEC 68-2-6 (TEST Fc) / IEC1131-2 & IEC 68-2-27 (TEST Ea)				
Weight (approx.) (g)		158	128	154 / 146	141 / 136	162 / 154
Approvals						

Electrical Specification of Input Point		Electrical Specification of Output Point			
Input Type	DC (SINK or SOURCE)	Output Type	Relay-R	Transistor-T	
Input Current	24VDC 5mA	Current Specification	1.5A/1 point (5A/COM)	0.3A/1 point @ 40°C; When the output of Y0 and Y1 is high-speed pulse, Y0 and Y1 = 30mA	
Active Level	Off→On, above 16VDC On→Off, below 14.4VDC	Voltage Specification	Below 250VAC, 30VDC	30VDC	
Responding Time	About 10ms (An adjustment range of 0~20ms could be selected through D1020 and D1021)	Maximum Loading	75VA (Inductive) 90 W (Resistive)	9W/1 point	When the output of Y0 and Y1 is high-speed pulse, Y0 and Y1 = 0.9W (Y0 = 32kHz, Y1 = 10kHz)
		Responding Time	About 10 ms	Off→On 20us On→Off 30us	Y0 and Y1 are specified points for high-speed pulse

### 6 MODEL NAME & I/O CONFIGURATION

Model	Power	Input				Output			
		Point		Type		Point		Type	
		DI	AI	DI	AI	DO	AO	DO	AO
DVP10SX11R	24VDC	4	2	DC24V/5 mA Sink or Source	-20~20mA range(-1000~+1000) -10~+10V range(-2000~+2000)	2	2	Relay	-20~20mA (range:-2000~+2000) -10~+10V (range:-2000~+2000)
DVP10SX11T	-15%	4	2			2	2	Resistor	

### 7 INSTALLATION & WIRING

#### 7.1 PLC Mounting Arrangements and Wiring Notes

### Installation of the DIN rail

The DVP-PLC can be secured to a cabinet by using the DIN rail that is 35mm high with a depth of 7.5mm. When mounting the PLC on the DIN rail, be sure to use the end bracket to stop any side-to-side motion of the PLC, thus to reduce the chance of the wires being pulled loose. At the bottom of the PLC is a small retaining clip. To secure the PLC to the DIN rail, place it onto the rail and gently push up the clip. To remove it, pull down the retaining clip and gently pull the PLC away from the DIN rail. As shown on the right:

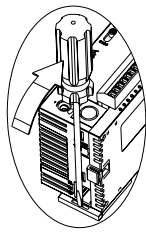

When installing the DVP series PLC, make sure that it is installed in an enclosure with sufficient space (as shown below) to its surroundings so as to allow heat dissipation.

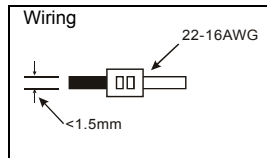
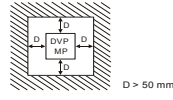

**Notes:**  
 1. Please use 22-16AWG (1.5mm) wiring (either single or multiple core) for I/O wiring terminals. The specification for the terminals is as shown on the left. PLC terminal screws should be tightened to between 1.95 kg-cm (1.7 in-lbs).  
 2. I/O signal wires or power supply should not run through the same multi-wire cable or conduit. Use Copper Conductor Only, 60/75 °C

### 7.2 Wiring Notes

#### Power Input Wiring

DVP-SX series input power supply is DC input. Please take a note of listed items when operating DVP-SX Series.

1. Please make sure the power is at terminals 24VDC and 0V (power range is 20.4VDC~28.8VDC). When voltage is lower than 20.4VDC, PLC will stop operating, all outputs will turn Off and ERROR LED will flash continuously.
2. If the power-off time is less than 10ms, the PLC still operates unaffectedly. If the power-off time is too long or the power voltage drops, the PLC will stop operating and all the outputs will be Off. Once the power is restored, the PLC will return to operate automatically. (There are latched auxiliary relays and registers inside of the PLC, please be aware when programming.)

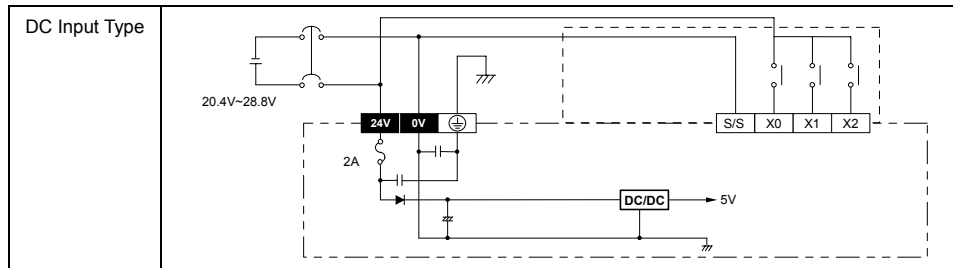

#### Safety Wiring

Since the PLC is in control of numerous devices, motion of either one device could affect the motion of other devices, therefore the breakdown of either one device would consequently be detrimental to the whole auto control system, and danger will thus be resulted. Please use the recommended wiring below for the power input:

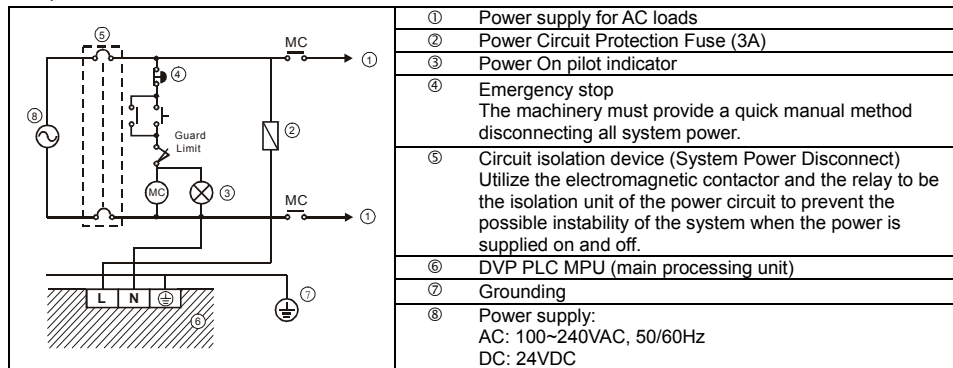

#### Input Point Wiring

The input signal of the input point is the DC power DC input. There are two types of DC type wiring: SINK and SOURCE, defined as follows:

◎ There are two types of DC type wiring: SINK and SOURCE, defined as follows:

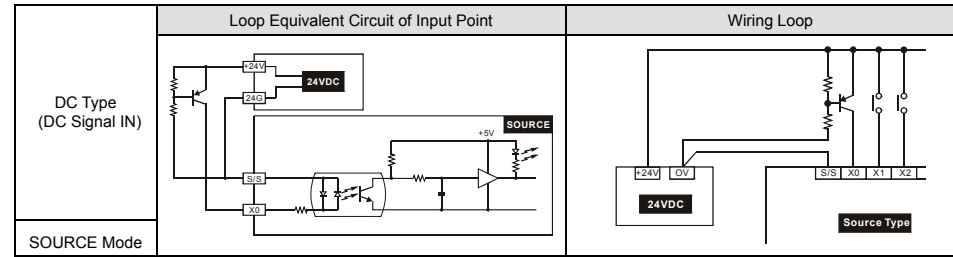
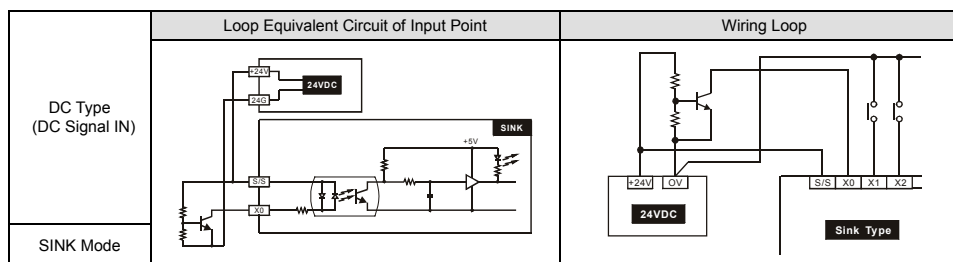
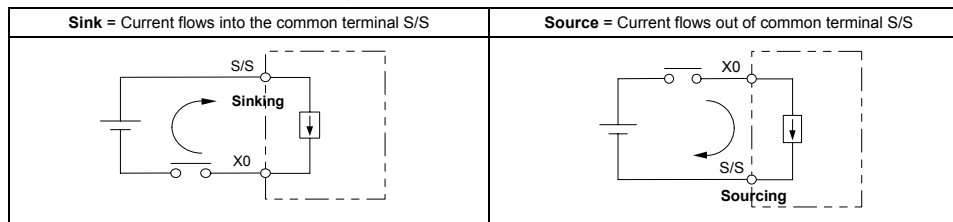

#### Output Point Wiring

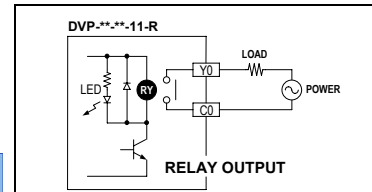

1. There are two kinds of DVP-SX Series PLC output modules: Relay and Transistor. For relevant electrical specification, please refer to the function specification.
2. Be careful with the connection of the common terminals when wiring outputs. For example, when wiring DVP12SX11R, output terminal Y0 uses one common terminal C0, Y1 uses C1, as shown below:

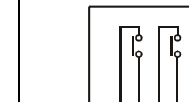
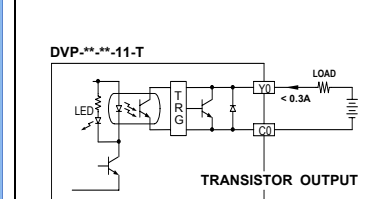

3. Isolated circuit: The optical coupler is used to isolate signals between PLC internal circuits and input modules.

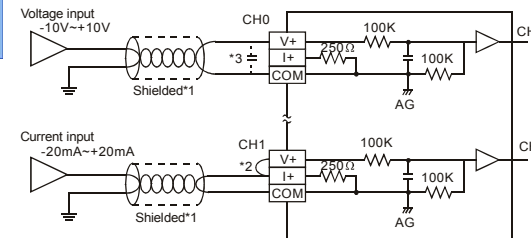

- Note 1: Please isolate analog input and other power wiring.  
 Note 2: If input signal is in current, please short out between V+ and I+ terminals.  
 Note 3: If the noise interference from loaded input wiring terminal is significant, please connect a capacitor with 0.1~0.47µF 25V for noise filtering.

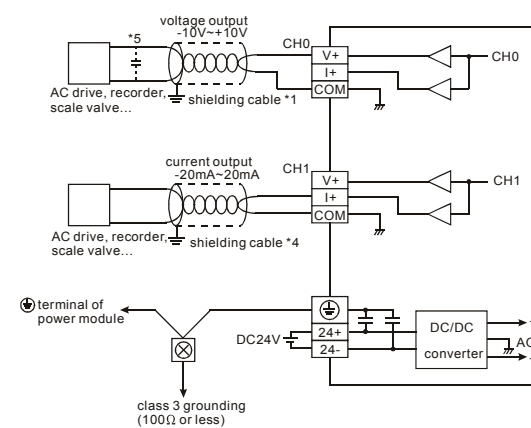

- Note 4: Please isolate analog output and other power wiring.  
 Note 5: If the noise interference from loaded input wiring terminal is significant, please connect a capacitor with 0.1~0.47µF 25V for noise filtering.  
 Note 6: Please connect ⊕ power module terminal and ⊖ analog output module terminal to system earth point and make system earth point be grounded or connects to machine cover.

Warning: DO NOT wire to the No function terminal ●

### 8 TRIAL RUN

- ◎ Power Indication  
 The "POWER" LED at the front of the MPU or the Expansion Units will be lit (in green) if the power is on. If the indicator is not on when the MPU is powered up, it means that the 24V DC power supply of the PLC is overloaded. It is thus necessary to remove the wiring on terminals +24V and 24G, and to use a 24VDC power supply instead. If the ERROR LED is blinking swiftly, it suggests that the +24V power supply of the PLC is insufficient.
- ◎ Low Voltage Indication  
 The "LOW V." LED on the Expansion Unit is an indication that the input power voltage is insufficient, thus all outputs of the expansion unit should be turned off.
- ◎ Low Battery Voltage Indication  
 There is also a "BAT.LOW" LED at the front of the MPU. When the LED is on, it indicates that the battery voltage is insufficient. Please change the battery (within 3 minutes) as soon as possible; otherwise the user programs and the data in latched area may be lost.
- Preparation
1. Prior to applying power, please verify that the power lines and the input/output wiring are correct. And be advised not to supply AC110V or AC220V into the I/O terminals, or it might short-circuit the wiring and would cause direct damage to the PLC.

2. After using the peripheral devices to write the program into the MPU and that the ERROR LED of the MPU is not on, it means that the program in use is legitimate, and it is now waiting for the user to give the RUN command.
3. Use HPP to execute the forced On/Off test of the output contact.

#### Operation & Test

If the "ERROR" LED of the MPU is not blinking, use RUN/STOP switch or the peripheral devices (HPP or WPLSoft) to give the RUN command, and the RUN indicator will then be on. If the "RUN" LED is not on, it indicates that there is no program inside the PLC.

HPP could be utilized to monitor the settings and the registered values of the timer (T), the counter (C) and the data register (D) during operation, and moreover, to force the output contacts to conduct the On/Off action. If the ERROR LED is on (but not blinking), it means that the setting of the user's program has exceeded the preset time-out limit. At this case, please turn the PLC RUN/STOP switch to STOP, and find out the address of the time-out program by special data register D1008. "WDT" instruction can be used to solve the problem.

#### PLC Input/Output Reaction Time

The total reaction time from the input signal to the output operation is calculated as follows:  
 Reaction Time = input delay time + program scan time + output delay time

Input delay time	Factory setting: 10 ms. Please refer to the usage of special register D1020~1021.
Program scan time	Please refer to the usage of special register D1010.
Output delay time	Relay module: 10ms. Transistor module: 20~30us.

#### Basic Commands and Application Commands of the PLC:

1. The basic commands and the application commands of the MPU of this series are totally applicable to the DELTA DVP-PLC SA/SX/SC Series MPU. Refer to the DELTA PLC Technique Application Manual for relevant basic commands and application commands.
2. The DVPHPP handheld programming panel and the WPLSoft (the Windows version) editing program of the ladder diagram are both good for use with the DELTA DVP-PLC. Also, the PLC could connect with the DVP12SX MPU through specific transmission wire to execute the program transmission, the MPU control and the program monitoring.

### 9 TROUBLESHOOTING

Judge the errors by the indicators on the front panel. When errors occurred on DVP PLC, please check:

- ◎ "POWER" LED  
 There is a "POWER" LED at the front of the MPU. When the MPU is powered On, the green LED light will be on. If the indicator is not on when the MPU is powered up and with the input power being normal, it is an indication that the PLC is out of order. Please have this machine replaced or have it repaired at a dealer near you.
- ◎ PLC "RUN" LED  
 Identify the status of the PLC. When the PLC is in operation, this light will be on, and users could thus use HPP or the editing program of the ladder diagram to give commands to make the PLC "RUN" or "STOP".
- ◎ "ERROR" LED  
 If incorrect programs are input to the MPU, or that the commands and the components exceed the allowable range, the indicator will blink. At this moment, the user should check both the error codes saved in the MPU data register D1004 and the Error Code Table below to correct the programs. The address that the error occurs will be stored in data register D1137 (the address saved in D1137 is invalid in case of common loop error).  
 When the ERROR LED is on (not blinking), users should make a judgment from the special relay M1008 of the MPU. If it is On, it indicates that the execution time of the program loop has exceeded the time-out setting (set by D1000). Please turn the PLC RUN/STOP switch to STOP, and find out the address of the time-out program by special data register D1008. "WDT" instruction can be used to solve the problem. Once program modification is completed, user can re-download the program of PLC and the ERROR LED will be off. If the ERROR LED is still keep on, please turn off the power and check if there's any noise or any conductive invader inside the PLC.
- ◎ "BAT.LOW" LED  
 When the battery voltage is low, the "BAT.LOW" LED will be on, and the battery should be replaced as soon as possible; otherwise the user program and the data in latched area will be lost. (On the unplugged PLC, please change the battery within 3 minutes to retain the PLC's internal user programs and data). Choose lithium battery TDRTL-2150/S. Please refer to the following table for battery life information.

Temperature(°C)	0	25	50	70
Life(Years)	9	8	6	5

Precision of calendar timer :  
 At 0°C/32°F, less than -117 seconds error per month.  
 At 25°C/77°F, less than 52 seconds error per month.  
 At 55°C/131°F, less than -132 seconds error per month.

- ◎ "Input" LED  
 The On/Off signals of the input point could be displayed through the "Input" LED, or the status of the input point could be monitored through the device monitoring function of HPP.
- ◎ "Output" LED  
 Output LED indicates if the output signals are On or Off. Please check the following items when the LED On/Off indication does not correspond to the commands: 1. Output contacts may be melted and stuck together due to a short circuit or current overload. 2. Check wiring and verify that the screws are tight.