



S1B8698200

⚠️ DANGER

HAZARD OF ELECTRIC SHOCK, EXPLOSION, OR ARC FLASH

- Read and understand this quick start guide before performing any procedure with this drive.
 - The user is responsible for compliance with all international and national electrical code requirements with respect to grounding of all equipment.
 - Many parts of this drive, including the printed circuit boards, operate at the line voltage. **DO NOT TOUCH.** Use only electrically insulated tools.
 - **DO NOT** touch unshielded components or terminal strip screw connections with voltage present.
 - **DO NOT** short across terminals PA/+ and PC/- or across the DC bus capacitors.
 - Before servicing the drive:
 - Disconnect all power, including external control power that may be present.
 - Place a "DO NOT TURN ON" label on all power disconnects.
 - Lock all power disconnects in the open position.
 - **WAIT 15 MINUTES** to allow the DC bus capacitors to discharge.
 - Measure the voltage of the DC bus between the PA/+ and PC/- terminals to ensure that the voltage is less than 42 Vdc.
 - If the DC bus capacitors do not discharge completely, contact your local Schneider Electric representative. Do not repair or operate the drive
 - Install and close all covers before applying power or starting and stopping the drive.
- Failure to follow these instructions will result in death or serious injury.**

Electrical equipment should be installed, operated, serviced, and maintained only by qualified personnel. No responsibility is assumed by Schneider Electric for any consequences arising out of the use of this product.

Information below is designed to use **single drive** connected to **single asynchronous motor with a motor cable length less than 50 meters (164ft)**. In any other case, consult the drive installation manuals (1755843 or 1755849) and programming manual (1755855) on www.schneider-electric.com.

1 Check the delivery of the drive

- Remove the drive from the packaging and check that it has not been damaged.

⚠️ WARNING

DAMAGED DRIVE EQUIPMENT

Do not operate or install any drive or drive accessory that appears damaged.
Failure to follow these instructions can result in death, serious injury, or equipment damage.

- Check that the drive reference printed on the label matches the delivery note and corresponding purchase order.

Write the drive Model Reference: _____ and Serial Number: _____

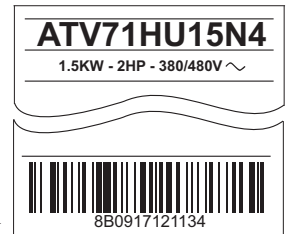

2 Check the line voltage compatibility

- Check that the **line voltage** is compatible with the supply range of the drive.
 Line voltage _____ Volts Drive voltage range _____ Volts
 Drive range: ATV●●●●●M3 = 200/ 240 V three-phase - ATV●●●●●N4 = 380 /480 V three-phase
 ATV●●●●●Y = 500 /690 V three-phase - ATV●●●●●S6 = 500 /600 V three-phase

3 Mount the drive vertically

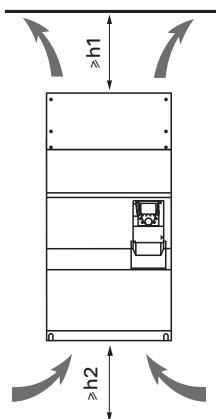

ATV71H	h1	h2
	mm (in.)	mm (in.)
D55M3X, D75M3X, D90N4	100 (3.9)	100 (3.9)
C11N4 ... C16N4, C11Y ... C16Y	150 (5.9)	150 (5.9)
C20N4 ... C28N4, C20Y ... C31Y	200 (7.8)	150 (5.9)
C31N4 ... C40N4	300 (11.8)	250 (9.8)
C50N4, C40Y ... C63Y	400 (15.7)	250 (9.8)

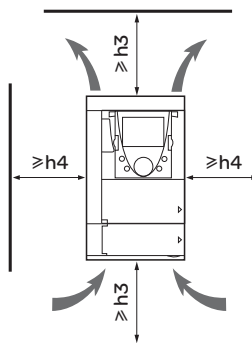

ATV71H	h3	h4
	mm (in.)	mm (in.)
D18M3X to D45M3X, D22N4 to D75N4 U22Y to D90Y,	100 (3.9)	50 (1.9)
037M3 to D15M3X, 075N4 to D18N4, U15S6X to U75S6X		

Free space in front of the drive: 10 mm (0.4 in.) minimum
 Install the drive vertically at ±10°.

For a surrounding air temperature up to 50 °C (122°F), see installation manual (1755843 or 1755849) on www.schneider-electric.com for other thermal conditions.

4 Connect the drive: Power

- Wire the drive to the ground.
- Check circuit breaker rating or fuse rating (See SCCR annex S1B86988).
- Check that the motor voltage is compatible with the drive voltage. Motor voltage _____ Volts.
- Wire the drive to the motor.
- Wire the drive to the line supply.

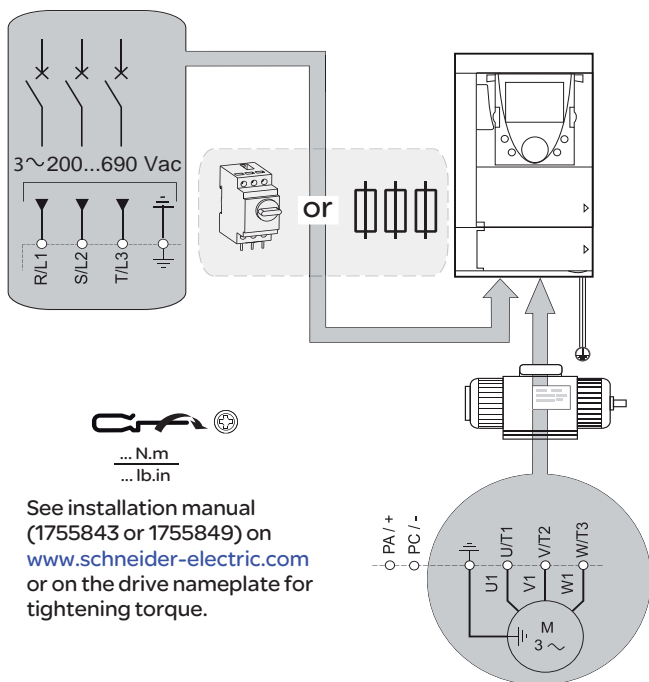

5 Connect the drive: Control by external reference (Fr1 = A11)

0.6 N.m
5.3 lb.in

- Wire the speed reference:

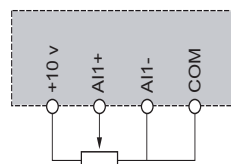

- Wire the command:

Control command 2-wire:
Parameter **CC C = 2 C**

L11: forward
L12: reverse

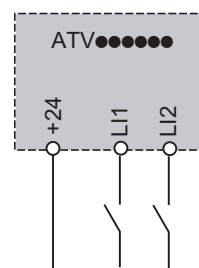
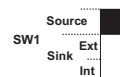

⚠️ DANGER

HAZARD OF FIRE OR ELECTRIC SHOCK

- To avoid overheating or loss of contact, connections must be carried out according to the cable sizes and tightening torques visible on the label stuck on the ATV●●.
- The use of multi-wire cable without a lug is forbidden for the mains connection.
- Carry-out a pull out test to check that terminal screws are correctly tighten.

Failure to follow these instructions will result in death or serious injury.

6 Apply power to the drive

- Check that Logic Inputs are not active (L11, L12, see drawing 5).
- Apply power to the drive.
- At first power up, it's displaying the drive state.

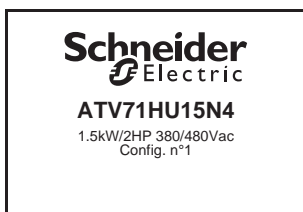

Display for 3 seconds following power-up



RDY	Term	+0.00Hz	0.0A
5 LANGUAGE			
English			
Français ✓			
Deutsch			
Español			
Italiano			
			Quick

Switches to [5 LANGUAGE] menu automatically after 3 seconds. Select the language and press ENT



RDY	Term	+0.00Hz	0.0A
2 ACCESS LEVEL			
Basic			
Standard ✓			
Advanced			
Expert			
			Quick

Switches to [2 ACCESS LEVEL] menu



RDY	Term	+0.00Hz	0.0A
1 DRIVE MENU			
1.1 SIMPLY START			
1.2. MONITORING			
1.3. SETTINGS			
1.4. MOTOR CONTROL			
1.5. INPUTS / OUTPUTS CFG			
Code			Quick

Switches to [1 DRIVE MENU]



RDY	Term	+0.00Hz	0.0A
MAIN MENU			
1 DRIVE MENU			
2 ACCESS LEVEL			
3 OPEN / SAVE AS			
4 PASSWORD			
5 LANGUAGE			
Code			Quick

Press ESC to return to [MAIN MENU].

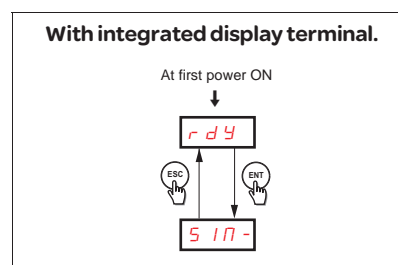

7 Set motor parameters for asynchronous motor.

- See on the motor Nameplate to set the following parameters.

Menu	Code	Description	Factory setting	Customer setting
5 IN - [1.1 SIMPLY START]	b F r	[Standard mot. freq]: Standard motor frequency (Hz)	[50Hz IEC] 5 0	
	n P r	[Rated motor power]: Nominal motor power on motor nameplate (KW)	drive rating	
	U n S	[Rated motor volt.]: Nominal motor voltage on motor nameplate (Vac)	drive rating	
	n C r	[Rated mot. current]: Nominal motor current on motor nameplate (A)	drive rating	
	F r S	[Rated motor freq.]: Nominal motor frequency on motor nameplate (Hz)	5 0	
	n S P	[Rated motor speed]: Nominal motor speed on motor nameplate (rpm)	drive rating	
	I t H	[Mot. therm. current]: Motor thermal protection current on the motor's rating plate (A)	drive rating	

Menu	Code	Description	Factory setting	Customer setting
5 IN - [1.1 SIMPLY START]	t U n	Set [Auto tuning] (tUn) parameter to Y E S . Auto-tuning is performed as soon as possible, then the parameter automatically changes to [Done] (dOnE).	n 0	

⚠️ ⚠️ DANGER

HAZARD OF ELECTRIC SHOCK OR ARC FLASH

- During auto-tuning, the motor operates at rated current.
- Do not service the motor during auto-tuning.

Failure to follow these instructions will result in death or serious injury.

⚠️ WARNING

DAMAGED DRIVE EQUIPMENT

- Asynchronous motor:** It is essential that the following parameters **U n S**, **F r S**, **n C r**, **n S P** and **n P r** are correctly configured before starting autotuning.
- Synchronous motor:** It is essential that the following parameters **n C r S**, **n S P S**, **P P n S**, **P H S**, **L d S** and **L 9 S** are correctly configured before starting autotuning.
- When one or more of these parameters have been changed after auto-tuning has been performed, **Y E S** will return to **d O n E** and the procedure will have to be repeated.

Failure to follow these instructions can result in death, serious injury, or equipment damage.

8 Set basic parameters

Menu	Code	Description	Factory setting	Customer setting
5 IN - [SIMPLY START]	A C L	[Acceleration]: Acceleration time (s)	3. 0	
	d E C	[Deceleration]: Deceleration time (s)	3. 0	
	L S P	[Low speed]: Motor frequency at minimum reference (Hz)	0	
	H S P	[High speed]: Motor frequency at maximum reference (Hz)	5 0	

9 Start the motor

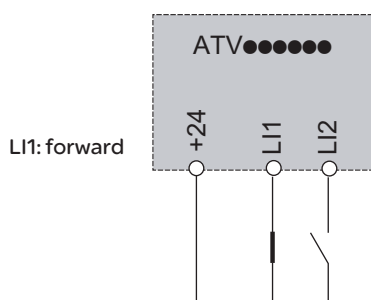

Graphic display terminal

RDY	Term	+38.0Hz	0.0A
Frequency ref.			
+ 38.0 Hz			
Code		Quick	

Integrated display terminal

↓
38.0

Menus structure

Access level

Comparison of the menus that can be accessed on the graphic display terminal/integrated display terminal

Graphic display terminal	Integrated display terminal	[2. ACCESS LEVEL] (LAC-)			
[2 ACCESS LEVEL] [3 OPEN/SAVE AS] [4 PASSWORD] [5 LANGUAGE] [1 DRIVE MENU]	L A C - - C O d - - S I n - S U P - S E t - - F C S - U S r -	[Basic] b A S	[Standard] S t d (factory setting)	[Advanced] A d U	[Expert] E P r
[1.1 SIMPLY START] [1.2 MONITORING] [1.3 SETTINGS] [1.11 IDENTIFICATION] [1.12 FACTORY SETTINGS] [1.13 USER MENU]	A single function can be assigned to each input.				
[6 MONITORING CONFIG.] A single function can be assigned to each input.	[1.4 MOTOR CONTROL] [1.5 INPUTS / OUTPUTS CFG] [1.6 COMMAND] [1.7 APPLICATION FUNCT.] [1.8 FAULT MANAGEMENT] [1.9 COMMUNICATION] [1.10 DIAGNOSTICS] [1.14 PROGRAMMABLE CARD] (1)				
[7 DISPLAY CONFIG.] Several functions can be assigned to each input	-				
Expert parameters Several functions can be assigned to each input.	E P r -				

(1) can be accessed if the PLC card is present.

Accessing SIMPLY START and parameters.

A dash appears after menu and submenu codes to differentiate them from parameter codes.
 Example: [1.1 SIMPLY START] (SIM-), [2/3 wire control] (tcc) parameter.

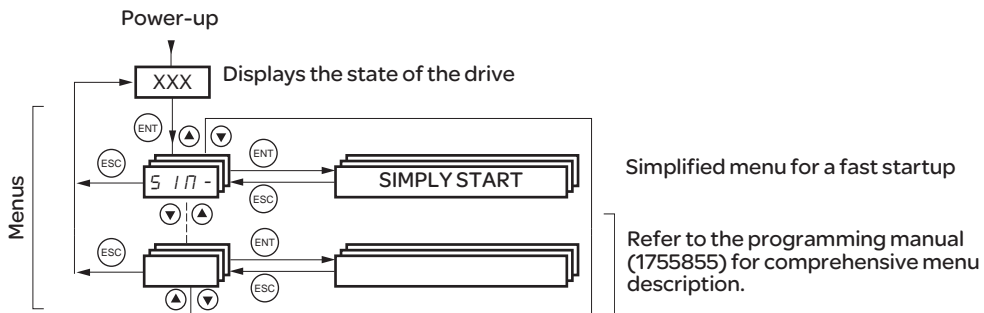

Certificate CE/ATEX

See on www.schneider-electric.com



CE ATV71H CE Certificate ATV71W CE Certificate ATV71E5 CE Certificate	 07ATEX0004X
--	--