

# Altivar<sup>®</sup> 58 TRX

## Adjustable Speed Drive Controllers

### Keypad Display VW3A58101

Instruction Bulletin  
Retain for future use.



[efesotomasyon.com](http://efesotomasyon.com)



See page 17 for the Minimum Start-Up Procedure.

## **⚠ DANGER**

### **HAZARDOUS VOLTAGE**

- Read and understand this bulletin in its entirety before installing or operating Altivar 58 *TRX* drive controllers. Installation, adjustment, repair, and maintenance of the drive controllers must be performed by qualified personnel.
- The user is responsible for conforming to all applicable code requirements with respect to grounding all equipment.
- Many parts in this drive controller, including printed wiring boards, operate at line voltage. **DO NOT TOUCH**. Use only electrically insulated tools.
- **DO NOT** short across DC bus capacitors or touch unshielded components or terminal strip screw connections with voltage present.
- Before servicing the drive controller:
  - Disconnect all power including external control power that may be present before servicing the drive controller.
  - Place a “DO NOT TURN ON” label on the drive controller disconnect.
  - Lock the disconnect in open position.
  - **WAIT TEN MINUTES** for the DC bus capacitors to discharge. Then follow the DC bus voltage measurement procedure on page 98 to verify that the DC voltage is less than 45 V. The drive controller LEDs are not accurate indicators of the absence of DC bus voltage.
- Install and close all covers before applying power or starting and stopping the drive controller.

**Electrical shock will result in death or serious injury.**

## TABLE OF CONTENTS

CHAPTER 1—OVERVIEW .....	7
Introduction .....	7
Product Range .....	7
Scope of Bulletin and Related Documentation .....	7
Application Information .....	8
Firmware Revision Information .....	9
Keypad Display .....	11
Mounting .....	12
Remote Mounting .....	12
Setting the 50/60 Hz Switch .....	13
Function of Keys and Meaning of Displays .....	15
Quick Configuration .....	16
Minimum Start-Up .....	17
Procedure: .....	17
Access Levels .....	18
Menu Hierarchy .....	19
Principles of Programming .....	21
CHAPTER 2—MENUS .....	23
Language Menu .....	23
Macro-Configuration Menu .....	23
Customizing the Macro-Configuration .....	26
Drive Controller Identification Screen .....	26
Increasing the Power Rating for Variable Torque Applications .....	27
1—Display Menu .....	28
2—Adjust Menu .....	29
Additional Adjustment Parameters for Material Handling .....	35
Additional Adjustment Parameters for General Use .....	37
Additional Adjustment Parameters for Variable Torque .....	38
Additional Adjustment Parameters After I/O Reassignment .....	39
3—Drive Menu .....	41
Parallel, Undersized, and Special Motor Applications .....	42
4—Control Menu .....	52
5—I/O Menu .....	58
Using the Logic Inputs .....	65
Run Forward and Run Reverse .....	65
2-wire Control .....	65
3-wire Control .....	65
Ramp Switching .....	66
Jog .....	66
+Speed/-Speed .....	66
Preset Speeds .....	69

Reference Switching (Auto/Manual) . . . . .	70
Freewheel Stop (Coast to Stop) / Run Permissive . . . . .	70
DC Injection Braking . . . . .	70
Fast Stop . . . . .	71
Motor Switching . . . . .	71
Second Torque Limit . . . . .	72
Fault Reset . . . . .	72
External Fault . . . . .	73
Force to Local . . . . .	73
Auto-tuning . . . . .	73
Encoder Inputs . . . . .	73
Speed Regulation . . . . .	73
Summing Speed Reference . . . . .	73
Using the Analog Inputs . . . . .	74
Speed Reference Summing . . . . .	74
PI Regulator . . . . .	74
Assignment of AI2 and AI3 . . . . .	76
Using the Controller Relay and Logic Outputs . . . . .	77
Drive Running (RUN) . . . . .	77
Output Contactor Command (OCC) . . . . .	77
Frequency Threshold Attained (FtA) . . . . .	77
High Speed Attained (FLA) . . . . .	78
Current Threshold Attained (CtA) . . . . .	78
Frequency Reference Attained (SrA) . . . . .	78
Motor Thermal State Attained (tSA) . . . . .	78
Brake Logic Command (bLC) (This parameter is only assignable to R2) . . . . .	78
Loss of 4–20 mA Signal (APL) . . . . .	81
Frequency Threshold 2 Attained (F2A) . . . . .	81
Drive Thermal Threshold Attained (tAd) . . . . .	81
Using the Analog Outputs . . . . .	81
Motor Current . . . . .	82
Output Frequency . . . . .	82
Ramp Output . . . . .	82
Motor Torque . . . . .	82
Signed Motor Torque . . . . .	83
Signed Ramp . . . . .	83
PI Setpoint . . . . .	83
PI Feedback . . . . .	83
PI Error . . . . .	84
PI Integral Error . . . . .	84
Motor Power . . . . .	84
Motor Thermal State . . . . .	84
Drive Thermal State . . . . .	84

---

6—Fault Menu .....	85
7—Files Menu .....	89
Reinitializing the Drive Controller .....	91
File Operation .....	91
Access Code .....	92
8—Communication Menu .....	94
8—Application Menu .....	94
CHAPTER 3—DIAGNOSTICS AND TROUBLESHOOTING .....	95
Keypad Display and Indicating LEDs .....	95
Fault Storage .....	95
Using Fault Codes and Messages to Solve Problems .....	96
Maintenance .....	96
Precautions .....	97
Procedure 1: Bus Voltage Measurement .....	98
Procedure 2: Checking Supply Voltage .....	101
Procedure 3: Checking the Peripheral Equipment .....	102
Fault Codes and Messages .....	103
APPENDIX A—DRIVE CONTROLLER CONFIGURATION .....	109
APPENDIX B—OPTIONS AND ACCESSORIES .....	117
Spare Part List for ATV58 TRX Controllers .....	119



## CHAPTER 1—OVERVIEW

### Introduction

The Altivar 58 *TRX* (ATV58 *TRX*) series of adjustable frequency AC drive controllers is a Transparent Ready™ product line providing extended functionality and extended horsepower range for the Altivar 58 AC drive family. The ATV58 *TRX* series includes an analog output, expanded firmware capabilities, and a horsepower range up to 500 hp. As a Transparent Ready™ product equipped with an Ethernet communication card, the ATV58 *TRX* product line can be configured, controlled, monitored, and diagnosed over an Ethernet network using a standard Web browser. No special software or drivers are needed.

The ATV58 *TRX* controllers accept all of the current I/O options, communication card options, and hardware options, such as ventilation fan kits and conduit box kits. See Appendix B for a complete list of options.

### Product Range

The ATV58 *TRX* family drive controllers range from:

- 1–75 hp (0.75–55 kW) constant torque, 400/460 V, three-phase input
- 1–500 hp (0.75–315 kW) variable torque 400/460 V, three-phase input
- 0.5–7.5 hp (0.37–5.5 kW) constant torque, 208/230 V, single-phase input
- 0.5–30 hp (0.37–22 kW) variable torque, 208/230 V, single-phase input
- 2–40 hp (1.5–30 kW) constant torque (50 hp variable torque), 208/230 V, three-phase input

### Scope of Bulletin and Related Documentation

This bulletin covers the programming, monitoring, diagnostics, and operation of the ATV58 *TRX* drive controllers with the keypad display, part number VW3A58101U. Additional functionality can be obtained by installing the analog I/O option card (part no. VW3A58201U) or the digital I/O card (part no. VW3A58202U). The additional functionality provided by these option cards is documented in this bulletin. Many

communication protocols are supported by communication option cards. Additional documentation is supplied with the option card.

For other specific option cards, additional information is available in the manual provided with the card.

For additional information on parameter applications, refer to the *Altivar<sup>®</sup> 58 TRX AC Drives* catalog, 8806CT9901, available on-line at [www.SquareD.com](http://www.SquareD.com).

This keypad display is for use with the drive controllers listed in Table 1. For installation, wiring, start-up, and maintenance, consult the latest revision of the applicable drive controller instruction bulletin.

**Table 1: Drive Controller Instruction Bulletins**

Drive Controller	Instruction Bulletins
ATV58 TRX Type E	VVDED397052US
Econoflex™	30072-450-10
ATV58 TRX Type F	VVDED300011US
Flex58 TRX Chassis	30072-450-47
ATV58 TRX Type H	VVDED397048US
ATV58 TRX Type N	30072-450-01
Class 8998 Motor Control Center	80444-035-01

### Application Information

The 125–500 hp drive controllers are listed in instruction bulletin VVDED397048US, *Altivar 58 TRX Adjustable Speed Drive Controllers Installation Guide, Type H Controllers*, with ratings typically used for variable torque applications. With proper selection, this range of controllers can also be used in constant torque applications, such as compressors, conveyors, and extruders, where high performance is not required at low speeds. The 125–500 hp product ratings are for applications that require 100% rated torque down to 6 Hz. If the application requires more than 110% transient torque for one minute, select the appropriate horsepower product. For assistance with selecting the proper AC drive controller for constant torque applications, consult your local Square D drives specialist.

Application information is also available in product data bulletin SC100, *Adjustable Frequency Controllers Application Guide* available at [www.SquareD.com](http://www.SquareD.com), or the NEMA Standards Publication: *Application Guide For AC Adjustable Speed Drive Systems*.



## Firmware Revision Information

Over time, the functionality of the ATV58 product line has been upgraded to broaden its applications. This document can be used with earlier drive controllers, but not all of the parameters detailed in it will be accessible if a drive controller is not equipped with the most recent firmware. Keypad displays are backward compatible. Older keypad displays used on newer drive controllers will not display the new parameters.

The drive controller firmware revision label is located adjacent to the integrated MODBUS port on the front of the drive controller. The keypad display firmware revision label is located on the back cover of the keypad display. The firmware on the drive controller may be upgraded by installing a new control board, part number VX4A581U, and a new keypad display, part number VW3A58101U.

Table 2 lists the major product upgrades with approximate date of release, drive controller firmware, associated keypad display firmware, and a description of the major function upgrade.

**Table 2: Product Upgrade and Revision Level History**

Date	Drive Controller Firmware Revision	Associated Keypad Display Firmware Revision	Description of Major Function Upgrade
1Q 1998	V2.1 IE 06	V1.0 IE 04	Initial release of the ATV58 product
2Q 1999	V3.1 IE 14	V2.0 IE 07	<p>Extended the product range to include the 25–75 hp constant torque (100 hp variable torque) drive controllers.</p> <p>The following functions were added:</p> <ul style="list-style-type: none"> <li>• Display machine speed, <i>USP</i>, based on scaling factor coefficient, <i>USC</i>.</li> <li>• Display Motor power, <i>OPr</i>.</li> <li>• Ability to define DC injection current level, <i>SdC</i>.</li> <li>• Ability to invert response to the PI regulator speed reference signal, <i>PIC</i>.</li> <li>• Current limit adaptation as function of speed in VT mode, <i>Fdb</i>.</li> <li>• Ability to inhibit reverse operation, <i>rIn</i>.</li> <li>• Ability to define drive controller response to speed reference signal below low speed setting, <i>bSP</i>.</li> <li>• U shaped acceleration and decel ramp type, <i>rPt</i>.</li> </ul> <p>Motor thermal overload protection (Ith) range increased from 45%–105% to 25%–136%</p>

**Table 2: Product Upgrade and Revision Level History** (*continued*)

Date	Drive Controller Firmware Revision	Associated Keypad Display Firmware Revision	Description of Major Function Upgrade								
3Q 2000	V3.1 IE 16	V3.0 IE 08	Began production of 5–25 hp, 460 Vac variable torque rated drive controllers without the integrated EMC filter for 460 Vac installations where the filter is not required. Removing this filter allowed the product to be rated for additional horsepower at 460 Vac. These drive controllers have the ability to be configured for VT plus as described on page 27.								
3Q 2001	V4.1 IE 25	V4.1 IE 13	<p>Relay R2 is no longer factory set for an output contactor. The factory setting is “not assigned.”</p> <p>The following functions were added:</p> <ul style="list-style-type: none"> <li>• Run time meter function, <i>rth</i>, and watt-hour meter function, <i>APH</i>. Both meters can be reset with <i>rpr</i>.</li> <li>• Two additional jump frequencies are <i>JF2</i> and <i>JF3</i>.</li> <li>• A second programmable frequency threshold with logic output configuration, <i>F2d</i>, <i>F2A</i>.</li> <li>• The ability to provide torque limit via analog input AI3, activated by a logic input, <i>TLA</i> and <i>ATL</i>.</li> <li>• Minimum adjustment of nominal motor frequency, <i>FrS</i>, changed from 40 Hz to 10 Hz.</li> <li>• Ability to configure a freewheel stop below a programmable frequency with <i>Stt</i> and <i>FFT</i>.</li> <li>• PI regulator has been enhanced to accept programmable setpoints through the keypad display with the use of logic inputs <i>PR2</i> and <i>PR4</i>.</li> <li>• PI regulator has been enhanced with time-constant filter on feedback, <i>PSP</i>.</li> <li>• Parameter, <i>tbr</i>, for a baud rate selection on an integrated MODBUS port.</li> <li>• Operation of an extremely undersized motor and the ability to configure an output voltage test mode by configuring <i>PSM</i>.</li> <li>• Ability to configure loss of follower fault to run at pre-set speed, <i>LFF</i>, and signal loss of follower with logic output, <i>APL</i>.</li> </ul> <p>Additional assignments possible to an analog output on an option card:</p> <table border="0" style="width: 100%;"> <tr> <td>• Signed ramp output, <i>ORS</i></td> <td>• Motor power, <i>OPR</i></td> </tr> <tr> <td>• PI setpoint, <i>OPS</i></td> <td>• PI feedback, <i>OPF</i></td> </tr> <tr> <td>• PI error, <i>OPE</i></td> <td>• PI integral, <i>OPI</i></td> </tr> <tr> <td>• Motor thermal state, <i>THR</i></td> <td>• Drive thermal state, <i>THD</i></td> </tr> </table> <p>Compatible with Ethernet, MODBUS®, TCP/IP communication card, and Forced local function.</p>	• Signed ramp output, <i>ORS</i>	• Motor power, <i>OPR</i>	• PI setpoint, <i>OPS</i>	• PI feedback, <i>OPF</i>	• PI error, <i>OPE</i>	• PI integral, <i>OPI</i>	• Motor thermal state, <i>THR</i>	• Drive thermal state, <i>THD</i>
• Signed ramp output, <i>ORS</i>	• Motor power, <i>OPR</i>										
• PI setpoint, <i>OPS</i>	• PI feedback, <i>OPF</i>										
• PI error, <i>OPE</i>	• PI integral, <i>OPI</i>										
• Motor thermal state, <i>THR</i>	• Drive thermal state, <i>THD</i>										
4Q 2001	V4.2 IE 28	V4.1 IE 13	PI regulator has been enhanced to work with Auto/Manual (reference switching) <i>PAU</i> , <i>PIF</i> , <i>PIM</i> .								

**Table 2: Product Upgrade and Revision Level History** (*continued*)

Date	Drive Controller Firmware Revision	Associated Keypad Display Firmware Revision	Description of Major Function Upgrade
3Q 2002	V5.1 IE 32 V5.2 IE 09 <sup>[1]</sup>	V5.1 IE 19 V5.2 IE 27 <sup>[1]</sup>	<p>Launched the ATV58 <i>TRX</i> series.</p> <p>Extended the product range to include the 125–500 hp drive controllers for variable torque applications.</p> <p>Added an analog output to the product.</p> <p>The following functions were added:</p> <ul style="list-style-type: none"> <li>• Ability to run at the last speed on loss of follower, <i>RLS</i>.</li> <li>• Increased adjustment range on two PI parameters, <i>RPG</i> and <i>RIG</i>.</li> <li>• Ability to assign a logic input to an external fault contact, <i>EDD</i>.</li> <li>• Ability to assign a logic output to drive temperature alarm and select alarm point, <i>tAd</i> and <i>dtA</i>.</li> </ul>
2Q 2003	V5.3 IE 43	V5.3 IE 32	<p>The following functions were added:</p> <ul style="list-style-type: none"> <li>• The ability to adjust the motor speed from the customer-defined units display, <i>LCU</i>, while in local control mode, using the keypad display's up/down arrow keys.</li> <li>• Enhanced auto restart functionality to allow setting the number of restart attempts, <i>nAr</i>, and the time delay between attempts, <i>tAr</i>.</li> <li>• The ability to change output phase rotation (motor direction) using parameter <i>ACb</i>.</li> </ul>

<sup>[1]</sup> V5.2 IE 09 is the 125–500 hp revision and can use keypad display firmware revision V5.1 or greater.

## Keypad Display

The keypad display allows:

- Display of the drive controller part number, electrical values, parameters, and faults
- Adjustment and configuration of the drive controller
- Local command
- Storage of four controller configurations which can be read or downloaded to multiple drive controllers of the same horsepower and firmware revision

## Mounting

To mount the keypad display, first remove the protective cover. Insert the keypad display into the SUB-D connector and turn the retaining screw clockwise until finger-tight.

**Figure 1: Removal of Protective Cover**

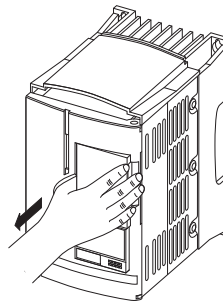

**Figure 2: Drive Controller with Keypad Display Mounted**

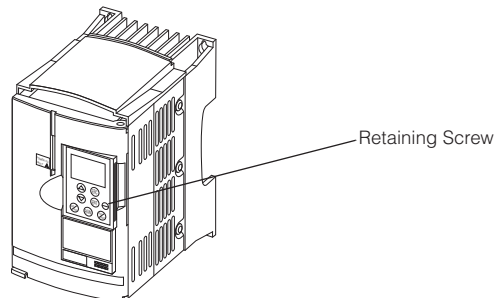

The keypad display can be mounted and removed while there is power to the drive controller. If the keypad display is removed while command of the drive controller from the keypad display is active, the drive controller will trip on the serial link fault. See *S L F* in Table 27 beginning on page 103.

## Remote Mounting

To remotely mount the keypad display, use the keypad display remote mounting kit, part number VW3A58103. This kit has an IP65 rating. It contains a three meter (9.8 ft.) cable with connectors, parts

for mounting the keypad display on the cover of an enclosure, and an instruction sheet.

### Setting the 50/60 Hz Switch

**⚠ DANGER**

**HAZARDOUS VOLTAGE**

- Read and understand this bulletin in its entirety before installing or operating ATV58 *TRX* drive controllers. Installation, adjustment, repair, and maintenance of these drive controllers must be performed by qualified personnel.
- The user is responsible for conforming to all applicable code requirements with respect to grounding all equipment.
- Many parts in this drive controller, including printed wiring boards, operate at line voltage. **DO NOT TOUCH.** Use only electrically insulated tools.
- **DO NOT** short across DC bus capacitors or touch unshielded components or terminal strip screw connections with voltage present.
- Disconnect all power before servicing the drive controller. **WAIT TEN MINUTES** until the DC bus capacitors discharge. Then follow the DC bus voltage measurement procedure on page 98 to verify that the DC voltage is less than 45 V. The drive controller LEDs are not accurate indicators of the absence of DC bus voltage.

**Electrical shock will result in death or serious injury.**

Figure 3 shows the location of the 50/60 Hz switch on the drive controller. **Before powering up the drive controller and using the keypad display, you must set the 50/60 Hz switch to correspond with the frequency of the incoming AC power.**

Unlock and open the cover to access the 50/60 Hz switch on the control board. If an option card is present, the switch may not be accessible through the card. Set the switch to the position corresponding to the frequency of the incoming AC power.

**Figure 3: Location of 50/60 Hz Switch**

The nominal motor voltage (UnS) in the 3—Drive menu is initially configured by the switch position:

For the 50 Hz Position:  
-230 V, 50 Hz for ATV58••••M2  
-400 V, 50 Hz for ATV58••••N4

For the 60 Hz Position (Factory Setting):  
-230 V, 60 Hz for ATV58••••M2  
-460 V, 60 Hz for ATV58••••N4

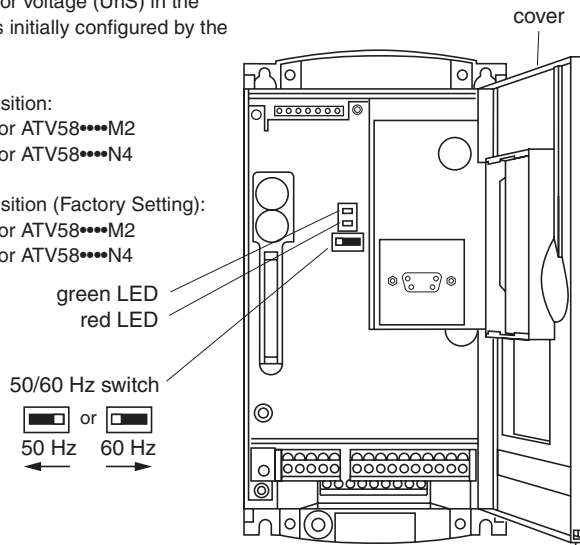



### Function of Keys and Meaning of Displays

Figure 4 shows the front of the keypad display. The keys and displays are explained below.

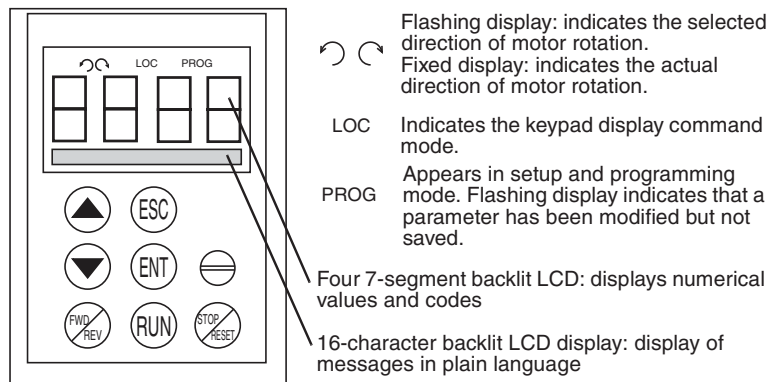
**Figure 4: Front View of Keypad Display**





  Press to move within the menus or among the parameters, and to scroll a numeric value up or down.

 Press to return to the previous menu, or to abandon an adjustment in progress and return to the original value.

 Press to select a menu, or to validate and save a choice.

If command by the keypad display has been selected (parameter LCC in the 4—Control menu, set to YES) the following buttons become active and only function in this mode:

 Press to change the direction of motor rotation.

 Press to start the motor.

 Press to stop the motor or reset a fault. The STOP function can also stop the drive controller in terminal command mode if so configured (see page 57).

## Quick Configuration

### **WARNING**

#### **UNINTENDED EQUIPMENT ACTION**

- Parameter changes affect drive controller operation.
- Most parameter changes require pressing ENT. Some parameter changes, such as reference frequency, take effect as soon as you press the up or down arrow keys.
- Read and understand this manual before using the keypad display.

**Failure to follow these instructions can result in death, serious injury, or equipment damage.**

First prepare your program settings using the forms beginning on page 109.

Programming the Altivar 58 *TRX* controller is facilitated by internal checks. It is recommended that you access the menus and program in the following order. All of the steps are not obligatory in all cases.

1. Set the 50/60 Hz switch, (see page 14).
2. Select the language.
3. Select the macro-configuration.

*NOTE: 125-500 hp drive controllers have only the variable torque macro.*

4. Select 2 or 3-wire control in the 4—Control menu.
5. Configure parameters in the 3—Drive Configuration menu.
6. Assign the I/O in the 5—I/O menu.

*NOTE: If the selected Macro-Configuration is Hdg: Material Handling, logic input LI4 must be reassigned or unassigned before you can assign logic input LI3 to a new function.*

**If the Freewheel Stop / Run Permissive function is assigned to a logic input, the drive controller will not start the motor unless that logic input is connected to +24 V.**

7. Configure parameters in the 4—Control menu.
8. Configure the switching frequency type in the 3—Drive Configuration menu.



9. Configure the fault management parameters in the 6—Fault menu.
10. Make Communication or Application configurations (if one of these options is used).
11. Configure the settings in the 2—Adjust menu.

*NOTE: You must ensure that the functions which are programmed are compatible with the control scheme used.*

### Minimum Start-Up

This procedure can be used as a minimum start-up:

- In simple applications where the drive controller factory settings are sufficient
- In installations when it is necessary to turn the motor before fully completing the start-up sequence

Procedure:

1. Make sure that the 50/60 Hz switch is in the correct position, corresponding to the frequency of the incoming AC power, as shown on page 14.
2. Ensure that the macro-configuration factory setting is suitable for the application. Refer to Table 3 on page 24. If not, change the configuration in the Macro-Configuration menu as shown on page 25.  
*NOTE: 125-500 hp drive controllers have only the variable torque macro.*
3. Verify that the control scheme is compatible with the macro-configuration, ensuring that the necessary safety precautions have been taken. Refer to the drive controller instruction bulletin, VVDED397048US, for a typical wiring diagram.
4. Verify in the 3—Drive menu that the factory settings are compatible with the motor nameplate values. Refer to Table 11 on page 43. Modify them to match the nameplate values.
5. If necessary, adjust the parameters in the 2—Adjust menu (ramps, motor thermal protection, etc.). See Table 6 on page 30.

**If the Freewheel Stop/Run Permissive function is assigned to a logic input, the drive controller will not start the motor unless that logic input is connected to +24 V.**

## Access Levels

Figure 5: Rear View of Keypad Display

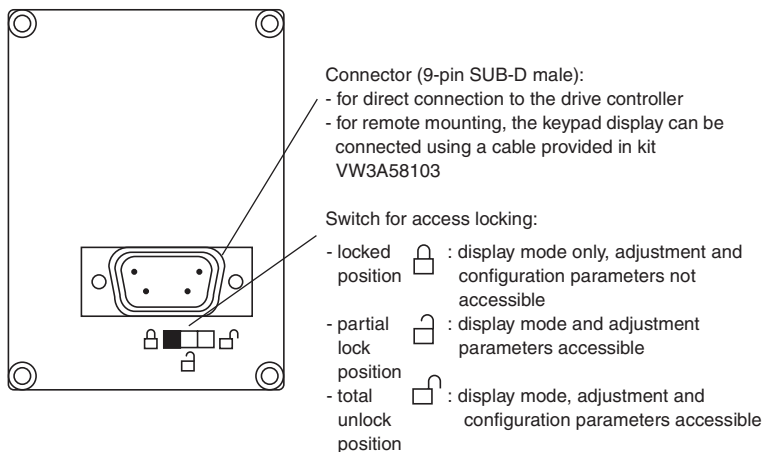

The position of the access locking switch on the back of the programming keypad display allows three levels of access to the menus. Access to the menus can also be prevented by using an access code (see the 7—File menu on page 90).

**Locked Position**  – **Display Mode:** use to prevent modifications to the drive controller programming.

- You can select the dialog language in the Language menu.
- You can display the macro-configuration or the pre-programmed values for the selected application in the Macro-Configuration menu.
- You can display the voltage and power rating of your drive controller in the Identification menu.
- You can display the electrical values, the operational status, or fault in the 1—Display menu.

**Partial Lock Position**  – **Display and Adjustment Modes:** this level is used during startup for access to basic setup parameters.

- You can do everything listed above.
- You can use the 2—Adjust menu to adjust parameters which are accessible when the motor is running.

**Total Unlock Position**  – **All modes:** this level is used during startup for access to advanced setup parameters.

*NOTE: Many parameters cannot be adjusted while the motor is running.*

- You can do everything listed in both access levels above.
- You can also select a different macro-configuration in the Macro-Configuration menu.
- You can adjust the performance of the motor-drive controller system, in the 3—Drive menu.
- You can configure the drive controller command to be either from the terminal strip, the keypad display, or the integrated serial link using the 4—Control menu.
- You can change the assignments of the inputs and outputs in the 5—I/O menu.
- You can configure motor protection, drive controller protection, and response after a fault has occurred in the 6—Fault menu.
- You can save the drive controller configurations, recall them from memory, return to factory settings, or protect your configuration in the 7—Files menu.
- You can adjust the parameters pertaining to communication in the 8—Communication menu, if a communication card is installed.
- You can access the 8—Application menu, if a customer application card is installed.

### Menu Hierarchy

Figure 6 shows the menus as they appear on the display when the access locking switch is in the total unlock position .

*NOTE: If an access code (password) has already been programmed, certain menus may not be modifiable, or may not be visible. In this case refer to “Access Code” on page 92 for how to enter the access code.*

Figure 6: Menus

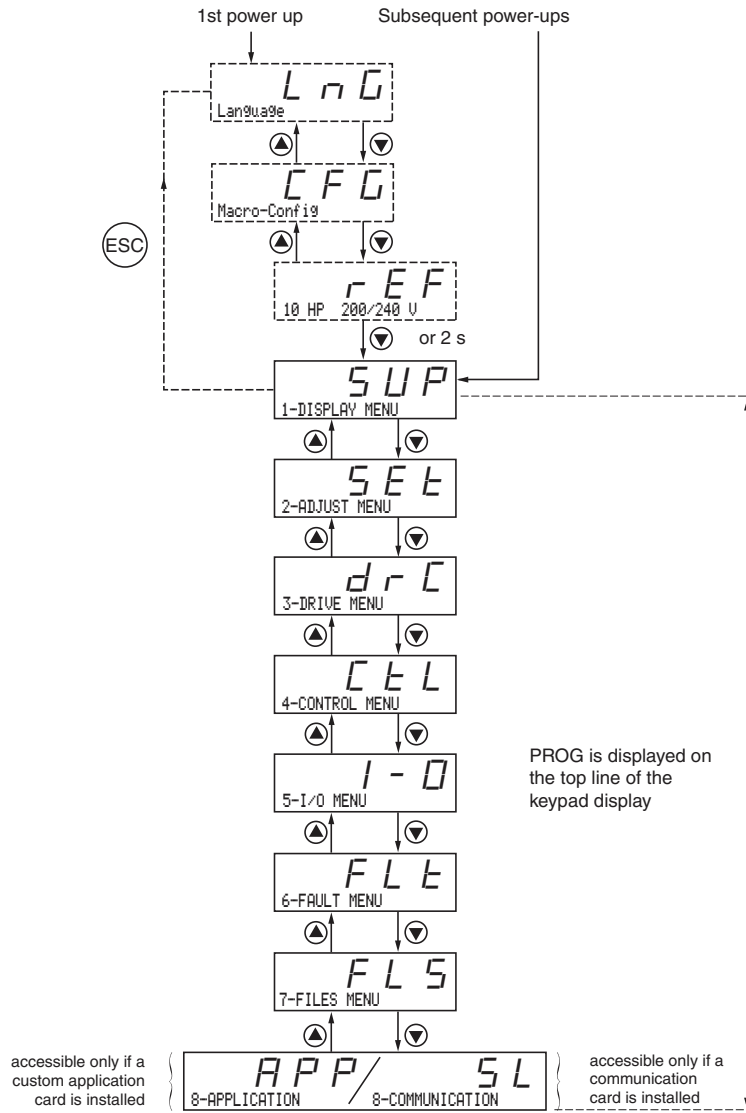

### Principles of Programming

The principle of programming is always the same, regardless of the access locking switch. Figures 7 and 8 show examples of programming steps.

**Figure 7: Language Selection Programming Example**

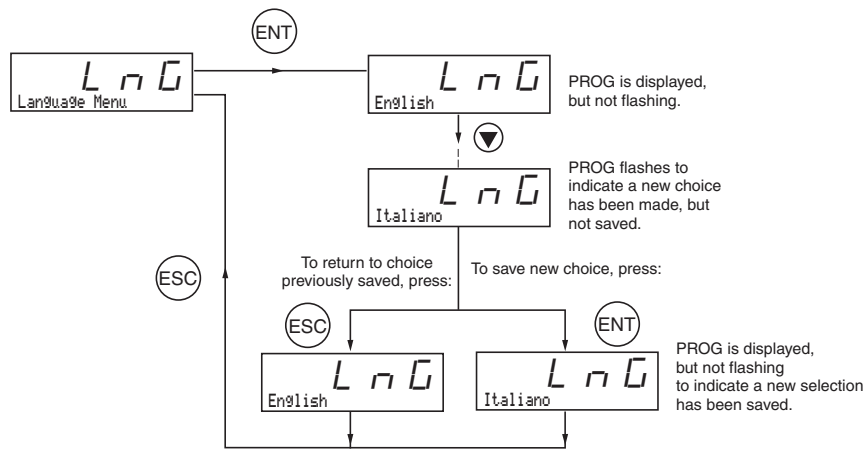

**Figure 8: Acceleration Time Programming Example**

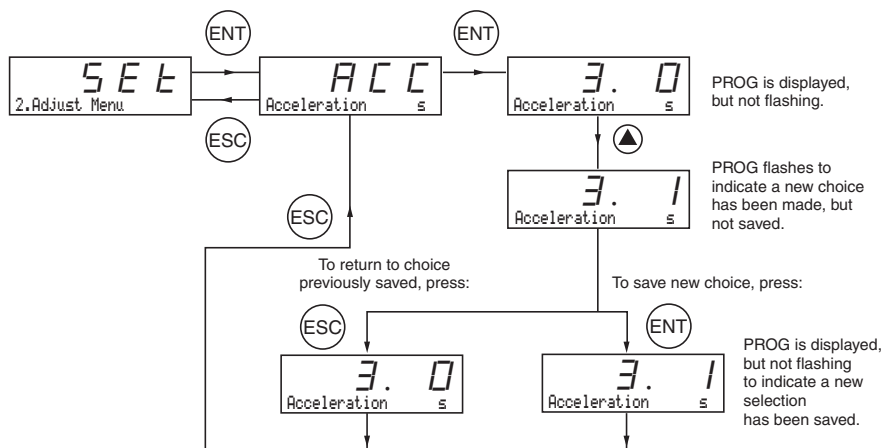



## CHAPTER 2—MENUS

This chapter explains menus and parameter functions.

### Language Menu

The Language menu (see Figure 7 on page 21) is accessible in each access level. The available languages are English (factory setting), French, German, Spanish, or Italian. The language can be modified with the motor stopped or running.

### Macro-Configuration Menu

Selecting a macro-configuration automatically configures the drive controller for an application. The Macro-Configuration menu can always be displayed, but can only be modified when the access level switch is in the total unlock, , position and when the motor is stopped. Three application types are available for drive controllers up to 100 hp:

- Material handling (Hdg)
- Variable torque for pump and fan applications (VT)
- General use (GEn)

The 125–500 hp drive controllers have only the variable torque macro.

The macro-configuration automatically assigns the inputs and outputs to functions suitable for the application. The parameters related to the I/O functions are then available for adjustment. **The factory-set macro-configuration is Material Handling.** If you customize the I/O to your application, the macro-configuration screen displays CUS:Customize as shown in Figure 10 on page 26. Table 3 shows the drive controller I/O assignments as a function of the macro-configuration selected when the drive controller is set for 2-wire control. For the logic input assignments when the drive controller is set for 3-wire control, refer to Table 12 on page 52.

**Table 3: Drive Controller I/O Assignments**

	Hdg: Material Handling <sup>[1]</sup>	GEn: General Use	VT: Variable Torque
Logic Input LI1	Forward	Forward	Forward
Logic Input LI2	Reverse	Reverse	Reverse
Logic Input LI3	2 Preset speeds	Jog	Auto/manual <sup>[3]</sup>
Logic Input LI4	4 Preset speeds	Freewheel stop <sup>[2]</sup>	DC injection braking <sup>[3]</sup>
Analog Input AI1	Reference summing	Reference summing	Speed reference 1 <sup>[3]</sup>
Analog Input AI2	Reference summing	Reference summing	Speed reference 2 <sup>[3]</sup>
Analog Output AO1	Motor frequency	Motor frequency	Motor frequency
Relay R1	Drive fault relay	Drive fault relay	Drive fault relay
Relay R2	Output contactor control	Motor thermal level attained	Frequency reference attained <sup>[3]</sup>

*NOTE: LI1, AI1, and R1 assignments are not visible in the 5—I/O menu. LI1 and R1 cannot be reassigned.*

<sup>[1]</sup> Factory default setting for 100 hp products and below.

<sup>[2]</sup> If the Freewheel Stop/Run Permissive function is configured, the drive controller will not start the motor unless the logic input is connected to +24 V.

<sup>[3]</sup> For 125–500 hp drive controllers the factory setting are:

LI3 = Fault Reset; LI4 = Not assigned; AI1 = Reference summing; AI2 = Reference summing; R2 = Drive running

**Table 4: I/O Extension Card Factory Presets**

	Hdg: Material Handling <sup>[1]</sup>	GEn: General Use	VT: Variable Torque
Logic Input LI5	8 preset speeds	Fault reset	Freewheel stop <sup>[1]</sup>
Logic Input LI6	Fault reset	Torque limit 2 <sup>[3]</sup>	Ramp switching
Analog Input AI3 <sup>[2]</sup> or Logic Inputs A, A-, B, B- <sup>[3]</sup>	Reference summing <sup>[2]</sup>	Reference summing <sup>[2]</sup>	Not assigned <sup>[2]</sup>
	Speed feedback	Speed feedback	Speed feedback
Logic Output LO	Current level attained	Output contactor command	High speed attained
Analog Output AO	Motor current	Motor current	Motor current

*NOTE: You must ensure that the functions which are programmed are compatible with the control scheme used.*

<sup>[1]</sup> If the Freewheel Stop / Run Permissive function is configured, the drive controller will not start the motor unless the logic input is connected to +24 V.

<sup>[2]</sup> With analog I/O extension card (VW3A58201U).

<sup>[3]</sup> With digital I/O extension card (VW3A58202U).



Transferring a file created for a drive controller without an I/O extension card to a drive controller with an I/O extension card may result in unexpected I/O assignment. Verify all I/O assignments. Do not assign I/O functions that are not used in the application.

**⚠ WARNING**

**UNINTENDED EQUIPMENT OPERATION**

LI1 has priority:

- If LI1 is closed while LI2 is active, the controller will respond to LI1.
- If the LI1 input is lost while LI2 is active, the controller will respond to LI2 and reverse directions.

The logic inputs must be programmed appropriately for the application to prevent the motor from spinning in an unintended direction.

**Failure to follow this instruction can result in death or serious injury.**

Modification of the macro-configuration requires two confirmations since it automatically changes the function assignments. When a change to the macro-configuration is requested the following screen is displayed:

**Figure 9: Macro-Configuration Validation**



Press ENT to proceed with change

Press ESC to return to the previous configuration

**⚠ WARNING**

**MACRO-CONFIGURATION OR PROGRAMMING RESET CAN CAUSE AN UNINTENDED EQUIPMENT ACTION**

- The factory default settings will be substituted for present settings when the macro-configuration is changed and confirmed.
- The factory default settings may not be compatible with the application. After changing the macro-configuration, verify that the factory settings are compatible with application requirements.

**Failure to follow these instructions can result in death, serious injury, or equipment damage.**

### Customizing the Macro-Configuration

The drive controller macro-configuration can be customized by changing the assignment of the inputs and outputs in the 5—I/O menu. The access locking switch must be in the total unlock, , position to customize the configuration. When an I/O assignment is modified, the macro-configuration screen displays the following:

**Figure 10: Customized Macro-Configuration**



### Drive Controller Identification Screen

This screen can be displayed in each access level. Refer to Figure 11 for the access path. This screen shows the power rating and the voltage indicated on the drive controller nameplate.

### Increasing the Power Rating for Variable Torque Applications

The power rating can be increased for variable torque applications on the drive controller identification screen for the following products:

- 208/230 Vac drive controllers 15 hp and larger (ATV58HD16M2–D46M2)
- 400/460 Vac drive controllers 25 hp and larger (ATV58HD28N4–D79N4)
- 460 Vac drive controllers 5 hp to 25 hp that do not have an integrated EMC filter (ATV58HU54N4X–D23N4X)

To increase the horsepower rating, begin at the *rEF* screen and follow this procedure:

1. Press ENT. *rEF* begins flashing.
2. Press  $\blacktriangle$ . A higher horsepower rating is displayed with a “+” sign indicating that the rating has been increased.
3. Press ENT then ESC. The drive controller is now configured for the higher horsepower rating.

**Figure 11: Drive Controller Identification Screen**

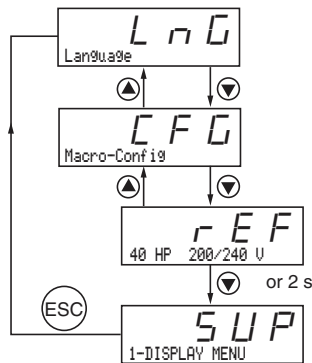

## 1—Display Menu

Display parameters can be viewed in any access level. You can scroll through these parameters with the motor running.

**Table 5: 1—Display Menu Parameters**

# Menu 1

Parameter	Code	Function	Units
Drive state Use this parameter to monitor drive controller status.	<i>r d Y</i> <i>r U n</i> <i>A C C</i> <i>d E C</i> <i>C L I</i> <i>d C b</i> <i>n S t</i> <i>O b r</i>	Drive controller status: indicates a fault or the state of the drive controller: rdY = drive controller is ready rUn = motor in steady state ACC = accelerating dEC = decelerating CLI = in current limit dCb = DC injection braking nSt = commanded to freewheel stop Obr = braking with deceleration ramp adaptation	—
Freq. Ref. - Hz	<i>F r H</i>	Reference frequency	Hz
Output Freq. - Hz	<i>r F r</i>	Output frequency applied to the motor	Hz
Motor Speed - RPM	<i>S P d</i>	Motor speed estimated by the drive controller. Based on nominal motor speed (nSP) entry. See Table 11 on page 43.	RPM
Motor Current - A	<i>L C r</i>	Motor current	A
Machine Spd.	<i>U S P</i>	Machine speed estimated by the drive controller. USP is proportional to rFr scaled by the coefficient, USC, which is adjustable in the 2—Adjust menu. If USP becomes greater than 9999, the display is divided by 1000.	—
Output Power - %	<i>O P r</i>	Output power estimated by the drive controller. 100% corresponds to nominal power.	%
Mains Voltage V	<i>U L n</i>	Mains voltage	V
Motor Thermal - %	<i>t H r</i>	Thermal state: 100% corresponds to the nominal motor thermal state. Above 118%, the controller trips on OLF (motor overload fault).	%
Drive Thermal - %	<i>t H d</i>	Thermal state of the drive controller: 100% corresponds to the nominal drive controller thermal state. Above 118%, the controller trips on OHF (drive overheating fault). It resets when the thermal state goes below 70%.	%
Last Fault	<i>L F t</i>	Displays the last fault.	—
Consumption	<i>A P H</i>	Energy consumed	kWh or MWh



NOTE: If USP is greater than 9999, the display value is USP/1000.

# Menu 1

**Table 5: 1—Display Menu Parameters** *(continued)*

Parameter	Code	Function	Units
Run time	r t H	Operating time (motor powered up) in hours	hrs
Freq. Ref	L F r	This adjustment parameter appears in place of the FrH parameter when command of the drive controller by the keypad display has been activated with the LCC parameter in the 4—Control menu (see page 56).	Hz
LCC	L C U	Local speed control in customer-defined units. Appears when the drive controller command from the keypad display has been activated using the LCC parameter in the 4—Control menu (see page 56). This parameter allows adjustment of the motor speed in customer-defined units. Use parameter USC: Machine Coef. to scale the customer unit value (see page 34). During adjustment, LCUA appears in the lower left-hand corner of the keypad display.	User dependant

## 2—Adjust Menu

The Adjust menu is accessible when the access locking switch is set to either partial lock, , or total unlock, . Adjustment parameters can be modified with the motor running; however, you must make all adjustments with the motor stopped to avoid unintended equipment action.

### **WARNING**

#### **PARAMETER CHANGES WHILE THE MOTOR IS RUNNING**

Changes made to adjustment parameters while the motor is running may cause unintended equipment action. When changing adjustment parameters, ensure that the motor is stopped.

**Failure to follow this instruction can result in death, serious injury, or equipment damage.**

# Menu 2

There are two types of adjustment parameters: parameters which are always accessible (fixed adjustment parameters), and parameters which may be accessible depending on:

- The macro-configuration selected
- The presence of an I/O extension card
- The input and output reassignments

The fixed set of adjustment parameters, shown in Table 6 beginning on page 30, are accessible in every macro-configuration.

**Table 6: 2—Fixed Set of Adjustment Parameters**

Parameter	Code	Description	Adjustment Range	Factory Setting
Freq. Ref. - Hz	L F r	Local speed control in Hz. Appears when the drive controller command from the keypad display has been activated using the LCC parameter in the 4—Control menu (see page 56).	LSP to HSP	
LCCU	L C U	Local speed control in customer-defined units. Appears when the drive controller command from the keypad display has been activated using the LCC parameter in the 4—Control menu (see page 56). This parameter allows adjustment of the motor speed in customer-defined units. Use parameter USC: Machine Coef. to scale the customer unit value (see page 34). During adjustment, LCUA appears in the lower left-hand corner of the keypad display.	User dependant	0.00

<sup>[1]</sup> I<sub>n</sub> = drive controller constant torque output current rating shown on the drive controller nameplate.

# Menu 2

**Table 6: 2—Fixed Set of Adjustment Parameters (continued)**

Parameter	Code	Description	Adjustment Range	Factory Setting
Inv. Phases	A C b	Electronic output phase inversion	No-Yes	No
		Allows for changing the phase rotation of the voltage at the output of the drive controller, from A-B-C to A-C-B, to change the direction of motor rotation. If this parameter is changed while the motor is running, the motor decelerates on the programmed ramp and then accelerates to the speed reference set point in the opposite rotation direction following the programmed ramp.		

## ⚠ CAUTION

### UNEXPECTED DIRECTION OF MOTOR ROTATION

- If parameter ACb is set to YES, upon returning to Factory Settings the parameter ACb returns to No (motor rotation will not be in the desired direction).
- Before changing parameter ACb, ensure that reversing the motor rotation direction is acceptable for the application.

**Failure to follow these instructions can result in injury or equipment damage.**

Acceleration -s	A C C	Acceleration and deceleration ramp times. Defined as the time between 0 Hz and FRS.	0.05 to 999.9	3 s
Deceleration -s	d E C		0.05 to 999.9	3 s
Low Speed - Hz	L S P	Low speed	0 to HSP	0 Hz
High Speed - Hz	H S P	High speed. Ensure that this adjustment is suitable for the motor and the application.	LSP to tFr	50/60 Hz depending on switch setting
Gain - %	F L G	Frequency loop gain. This parameter allows adjustment of the response time of the drive controller to sudden changes in the motor load. Decreasing the gain parameter slows the response time of the drive controller. Increasing the gain parameter makes the drive controller respond more quickly. This parameter should be increased in applications where the undesirable changes in motor speed occur due to changes in motor load. Applications that have fast cycle times or high torque requirements may require an increase in gain.	0 to 100	20

<sup>[1]</sup> I<sub>n</sub> = drive controller constant torque output current rating shown on the drive controller nameplate.

# Menu 2

**Table 6: 2—Fixed Set of Adjustment Parameters (continued)**

Parameter	Code	Description	Adjustment Range	Factory Setting
Stability - %	5 E R	Frequency loop stability.  This parameter allows adjustment of speed overshoot of the drive controller to sudden changes in the motor load. Increasing the stability setting dampens the overshoot. This parameter should be adjusted with the gain setting to tune the drive controller response to meet the desired performance on applications that have fast cycle times or high torque requirements.	0 to 100	20
ThermCurrent - A	1 E H	Current setting used for the motor thermal protection. Adjust ItH to the nominal current which appears on the motor nameplate. This provides Class 20 motor overload protection.	0.25 to 1.36 of $I_n$ <sup>[1]</sup>	Varies according to drive controller size.

## ⚠ CAUTION

### MOTOR OVERHEATING

- This drive controller does not provide direct thermal protection for the motor.
- Use of a thermal sensor in the motor may be required for protection at all speeds or loading conditions.
- Consult the motor manufacturer for the thermal capability of the motor when operated over the desired speed range.

**Failure to follow these instructions can result in injury or equipment damage.**

DC Inj. Time- s	E d C	DC injection braking time. If E d C = Cont, DC injection is continuous.	0 to 30 s Cont	0.5 s
-----------------	-------	---	-------------------	-------

<sup>[1]</sup>  $I_n$  = drive controller constant torque output current rating shown on the drive controller nameplate.



# Menu 2

*NOTE: DC Inj. Time is only available if automatic DC injection (AdC) is set to Yes.*

*NOTE: DC Inj. Current Level is only available if tdC is set to continuous.*

**Table 6: 2—Fixed Set of Adjustment Parameters (continued)**

Parameter	Code	Description	Adjustment Range	Factory Setting
dc I at rest - A	SdC	DC injection braking current level if tdC is set to continuous.	0.1 to 1.36 of $I_n$ <sup>[1]</sup>	Varies according to drive controller size.

## **⚠ WARNING**

### **NO HOLDING TORQUE**

- DC injection braking does not provide holding torque at zero speed.
- DC injection braking does not function during loss of power or drive controller fault.
- When required, use a separate brake for holding torque.

### **EXCESSIVE DC INJECTION BRAKING**

Application of DC injection braking for long periods of time can cause motor overheating and damage. Protect the motor from extended periods of DC injection braking.

**Failure to follow these instructions can result in death, serious injury, or equipment damage.**

NST Thresh-Hz	FFL	Freewheel stop trip threshold: when a stop on ramp or fast stop is requested, the type of stop selected is activated until the speed falls below this threshold.  Below this threshold, freewheel stop is activated. This parameter can only be accessed if the R2 relay is not assigned to the BLC: Brake Logic function, and if an on ramp or fast type stop has been selected in the 3—Drive menu under type of stop (Stt).	0 to HSP	0 Hz
Jump Freq. - Hz	JPF	Jump frequency with a bandwidth of +/- 2.5 Hz around JPF.  This function is used to suppress speeds which cause mechanical resonance.	0 to HSP	0 Hz
Jump Freq.2- Hz	JF2	Second skip frequency: same function as JPF, for a second frequency value.	0 to HSP	0 Hz

<sup>[1]</sup>  $I_n$  = drive controller constant torque output current rating shown on the drive controller nameplate.

*NOTE: Additional parameters appear in this menu if certain Macro-Configurations are selected. See Tables 7–9.*

# Menu 2

**Table 6: 2—Fixed Set of Adjustment Parameters** *(continued)*

Parameter	Code	Description	Adjustment Range	Factory Setting
Jump Freq.3- Hz	JF3	Third skip frequency: same function as JPF, for a third frequency value.	0 to HSP	0 Hz
Machine Coef.	USC	Machine speed coefficient. Coefficient applied to rFr permitting the display of machine speed by the parameter USP. $USP = rFr \times USC$	0.01 to 100.0	1.00
LSP Time - s	ELL5	Low speed run time. After operation at LSP for the amount of time defined by tLS, the motor is automatically commanded to stop. The motor restarts if the frequency reference is greater than LSP, if a run command continues to be present. "0" means that no time period is set.	0.0 to 999.9 s	0

<sup>[1]</sup>  $I_n$  = drive controller constant torque output current rating shown on the drive controller nameplate.

**Additional Adjustment Parameters for Material Handling**

Table 7 lists the additional parameters that are accessible when the macro-configuration is set to Material Handling.

**Table 7: 2—Additional Adjustment Parameters with Material Handling Macro-Configuration**

**Menu  
2**

*NOTE: UFr and SLP are unitless values. The percent value is only to provide a range for adjustment. For example, 50 on a 0 to 150 scale is one third of the maximum.*

Parameter	Code	Description	Adjustment Range	Factory Setting
IR Compens. - %	U F r	IR compensation  Allows adjustment of the default value of IR Compensation or the value measured during auto-tuning. The adjustment range is extended to 800% if the SPC parameter (special motor) is set to Yes in the 3—Drive menu (see page 50). Special motors include synchronous permanent magnet motors, synchronous wound field motors, and synchronous reluctance motors.  This parameter is used to adjust low speed torque for optimal performance. Adjust this parameter to compensate for the resistive voltage drop of the motor stator windings and the conductors connecting the motor and drive controller. This parameter is typically used to boost torque performance at low speed operation. If an autotune is performed, adjustment of this parameter is usually not required.	0 to 150% or 0 to 800%	100%
Slip Comp. - %	S L P	Slip compensation  Allows adjustment of the slip compensation around a fixed value set by the nSP parameter (motor nominal speed) in the 3—Drive menu (see page 43).  This parameter is used to adjust the slip compensation to improve speed regulation. Induction motors develop torque based on the slip, which is the difference between the speed of the rotating magnetic field in the stator and the speed of the rotor. As the load increases, the slip increases to produce the necessary torque.  In applications where the change in speed due to slip is undesirable, the slip compensation should be increased. When this parameter is increased, the drive controller will automatically increase the output frequency. The amount of increase is proportional to the increase of the load, allowing one setting for the entire speed range.	0 to 150%	100%
Preset SP.2- Hz	S P 2	Second preset speed	LSP to HSP	10 Hz
Preset SP.3- Hz	S P 3	Third preset speed	LSP to HSP	15 Hz

<sup>[1]</sup> I<sub>n</sub> = drive controller constant torque output current rating shown on the drive controller nameplate.

★ Parameters appear if an I/O extension card is installed.

# Menu 2

**Table 7: 2—Additional Adjustment Parameters with Material Handling Macro-Configuration**

Parameter	Code	Description	Adjustment Range	Factory Setting
Preset SP.4- Hz ★	SP4	Fourth preset speed	LSP to HSP	20 Hz
Preset SP.5- Hz ★	SP5	Fifth preset speed	LSP to HSP	25 Hz
Preset SP.6- Hz ★	SP6	Sixth preset speed	LSP to HSP	30 Hz
Preset SP.7- Hz ★	SP7	Seventh preset speed	LSP to HSP	35 Hz
Curr.Lev.Att: A ★	Ed	Current threshold above which the logic output or the relay changes to 1	0.25 to 1.36 of $I_n$ <sup>[1]</sup>	1.36 of $I_n$ <sup>[1]</sup>

<sup>[1]</sup>  $I_n$  = drive controller constant torque output current rating shown on the drive controller nameplate.

★ Parameters appear if an I/O extension card is installed.

**Additional Adjustment Parameters for General Use**

Table 8 lists the additional parameters that are accessible when the macro-configuration is set to General Use.

**Table 8: 2—Additional Adjustment Parameters with General Use Macro-Configuration**

**Menu  
2**

*NOTE: UFr and SLP are unitless values. The percent value is only to provide a range for adjustment. For example, 50 on a 0 to 150 scale is one third of the maximum.*

Parameter	Code	Description	Adjustment Range	Factory Setting
IR Compens. - %	U F r	<p>IR compensation</p> <p>Allows adjustment of the default value of IR Compensation or the value measured during auto-tuning.</p> <p>The adjustment range is extended to 800% if the parameter SPC (special motor) is set to Yes in the 3—Drive menu (see page 50). Special motors include synchronous permanent magnet motors, synchronous wound field motors, and synchronous reluctance motors.</p> <p>This parameter is used to adjust low speed torque for optimal performance. Adjust this parameter to compensate for the resistive voltage drop of the motor stator windings and the conductors connecting the motor and drive controller. This parameter is typically used to boost torque performance at low speed operation. If an autotune is performed, adjustment of this parameter is usually not required.</p>	0 to 150% or 0 to 800%	100%
Slip Comp. - %	S L P	<p>Slip compensation</p> <p>Allows adjustment of the slip compensation around a fixed value set by the motor nominal speed.</p> <p>This parameter is used to adjust the slip compensation to improve speed regulation. Induction motors develop torque based on the slip, which is the difference between the speed of the rotating magnetic field in the stator and the speed of the rotor. As the load increases the slip increases to produce the necessary torque.</p> <p>In applications where the change in speed due to slip is undesirable, the slip compensation should be increased. When this parameter is increased, the drive controller will automatically increase the output frequency. The amount of increase is proportional to the increase of the load, allowing one setting for the entire speed range.</p>	0 to 150%	100%
Jog Freq. -Hz	J O G	Frequency when operating in Jog	0 to 10 Hz	10 Hz
Jog Delay - s	J G t	Delay between two consecutive jog operations	0 to 2 s	0.5 s

### Additional Adjustment Parameters for Variable Torque

Table 9 lists the additional parameters that are accessible when the macro-configuration is set to Variable Torque.

**Table 9: 2—Additional Adjustment Parameters with Variable Torque Macro-Configuration <sup>[1]</sup>**

# Menu 2

*NOTE: V/f Profile is available only if the energy savings function (nld) is set to No.*

Parameter	Code	Description	Adjustment Range	Factory Setting
DC Inj.Curr.- A	ldC	DC injection braking current level. This parameter is accessible if a logic input is assigned to DC injection braking. After 30 seconds, ldC is automatically set to 0.5 lth if previously set to a higher value.	0.10 to 1.36 of I <sub>n</sub> <sup>[2]</sup>	Varies according to drive controller size.
V/f Profile - %	PFL	Volts/Hertz adjustment  This function is available in variable torque mode and if the Energy Economizer (Energy Savings) function (nld) is disabled.  This parameter is useful in applications where the user wishes to define the volts/hertz profile manually instead of having the drive controller perform this function with the Energy Economizer function. The 100% setting provides a linear V/Hz output from 0–FrS (nominal motor frequency).	0 to 100%	20%

<sup>[1]</sup> On the 125–500 hp drive controllers, Preset Speeds and Jog are also available. See Tables 7 and 8 for descriptions of these functions. IR Compensation appears on 125–500 hp drive controllers if the Special Motor parameter, SPC, is set to Yes in Menu 3.

<sup>[2]</sup> I<sub>n</sub> = drive controller constant torque output current rating shown on the drive controller nameplate.

### Additional Adjustment Parameters After I/O Reassignment

Table 10 lists the additional parameters that may be accessible after the inputs or outputs have been reassigned.

**Table 10: 2—Additional Adjustment Parameters After I/O Reassignment**

# Menu 2

Parameter	Code	Description	Adjustment Range	Factory Setting
Preset Sp.2-Hz	<i>S P 2</i>	Second preset speed	LSP to HSP	10 Hz
Preset Sp.3-Hz	<i>S P 3</i>	Third preset speed	LSP to HSP	15 Hz
Preset Sp.4-Hz	<i>S P 4</i>	Fourth preset speed	LSP to HSP	20 Hz
Preset Sp.5-Hz	<i>S P 5</i>	Fifth preset speed	LSP to HSP	25 Hz
Preset Sp.6-Hz	<i>S P 6</i>	Sixth preset speed	LSP to HSP	30 Hz
Preset Sp.7-Hz	<i>S P 7</i>	Seventh preset speed	LSP to HSP	35 Hz
Jog Freq. - Hz	<i>J O G</i>	Frequency when operating in jog	0 to 10 Hz	10 Hz
Jog Delay - s	<i>J G t</i>	Delay between two consecutive jog operations.	0 to 2 s	0.5 s
BrReleaseLev-Hz <sup>[4]</sup>	<i>b r L</i>	Brake release frequency	0 to 10 Hz	0 Hz
BrReleaseI -A <sup>[4]</sup>	<i>I b r</i>	Brake release current	0 to 1.36 of $I_n$ <sup>[3]</sup>	0 A

<sup>[1]</sup> Depending on the position of the 50/60 Hz switch.

<sup>[2]</sup> 100% corresponds to the nominal torque of a motor with horsepower size equal to that of the drive controller at its constant torque rating.

<sup>[3]</sup>  $I_n$  = drive controller constant torque output current rating shown on the drive controller nameplate.

<sup>[4]</sup> This parameter is not available on 125–500 hp drive controllers.

★ These parameters are available only with the I/O extension card installed.

# Menu 2

**Table 10: 2—Additional Adjustment Parameters After I/O Reassignment (continued)**

Parameter	Code	Description	Adjustment Range	Factory Setting
BrReleasTime -s <sup>[4]</sup>	<i>b r t</i>	Brake release time	0 to 5 s	0 s
BrEngageLev- Hz <sup>[4]</sup>	<i>b E n</i>	Brake engage frequency	0 to LSP	0 Hz
BrEngageTime -s <sup>[4]</sup>	<i>b E t</i>	Brake engage time	0 to 5 s	0 s
PI Prop. Gain	<i>r P G</i>	Proportional gain for PI regulator	0.01 to 100	1
PI Int. Gain-/s	<i>r I G</i>	Integral gain for PI regulator	0.01 to 100 /s	1 /s
PI Coeff.	<i>F b S</i>	Feedback scaling factor for PI regulator	1.0 to 100.0	1.0
PI Inversion	<i>P I C</i>	Inverts the PI feedback signal No: Normal Yes: Inverted	Yes - No	No
PI Filter -s	<i>P S P</i>	Used to adjust the low-pass filter time constant on the PI feedback signal.	0 to 10 s	0 s
PI Preset 2 - %	<i>P I 2</i>	Second preset PI reference. Available after a logic input has been assigned to PR4: PI4 Preset	0-100%	30%
PI Preset 3- %	<i>P I 3</i>	Third preset PI reference. Available after a logic input has been assigned to PR4: PI4 Preset	0-100%	60%
ATV th. fault	<i>d t d</i>	Drive thermal fault threshold above which the logic output goes to state 1, after a logic input has been assigned to tAd:ATV th. alarm.	0-118%	105%
Freq. Detect-Hz	<i>F t d</i>	Motor frequency threshold above which the logic output goes to state 1.	LSP to HSP	50/60 Hz <sup>[1]</sup>
Freq.Lev.2- Hz	<i>F 2 d</i>	Same function as Ftd for a second frequency value	LSP to HSP	50/60 Hz <sup>[1]</sup>

<sup>[1]</sup> Depending on the position of the 50/60 Hz switch.

<sup>[2]</sup> 100% corresponds to the nominal torque of a motor with horsepower size equal to that of the drive controller at its constant torque rating.

<sup>[3]</sup>  $I_n$  = drive controller constant torque output current rating shown on the drive controller nameplate.

<sup>[4]</sup> This parameter is not available on 125–500 hp drive controllers.

★ These parameters are available only with the I/O extension card installed.



# Menu 2

**Table 10: 2—Additional Adjustment Parameters After I/O Reassignment (continued)**

Parameter	Code	Description	Adjustment Range	Factory Setting
Curr.Lev.Att- A	C L d	Current threshold above which the logic output or relay goes to state 1.	0.25 to 1.36 of $I_n$ [3]	1.36 of $I_n$ [3]
ThermLevAtt - %	t t d	Motor thermal state threshold above which the logic output or relay goes to state 1 (high).	0 to 118%	100%
Torque lim2 -A [4]	t L 2	Second torque limit, activated by a logic input.	0% to 200% [2]	200%
DC Inj. Curr. -A	I d C	DC injection braking current level. Accessible if a logic input is assigned to DC injection braking. After 30 s, IdC is automatically set to 0.5 lTH if previously set to a higher value.	0.10 to 1.36 of $I_n$ [3]	0.7 lTH
Accelerate 2- s Decelerate 2- s	A C 2 d E 2	Second acceleration and deceleration ramp times. These parameters are accessible if a logic input is assigned to ramp switching or if Frt is not 0.	0.05 to 999.9	5 s
TachFBCoeff ★	d t S	Tachometer scaling factor associated with the tachometer feedback function: $dtS = \frac{9}{\text{tachometer voltage at HSP}}$	1 to 2	1

[1] Depending on the position of the 50/60 Hz switch.

[2] 100% corresponds to the nominal torque of a motor with horsepower size equal to that of the drive controller at its constant torque rating.

[3]  $I_n$  = drive controller constant torque output current rating shown on the drive controller nameplate.

[4] This parameter is not available on 125–500 hp drive controllers.

★ These parameters are available only with the I/O extension card installed.

## 3—Drive Menu

This menu is accessible when the access locking switch is in the total unlock, , position. The parameters can only be modified when the motor is stopped.

Optimal performance is obtained:

- By ensuring that the input frequency selection switch is properly set (see page 14)
- By entering the motor nameplate values into the Drive menu parameters
- By initiating an autotune (on a standard asynchronous motor). See page 45 for more information concerning the autotune function (tUn).

### Parallel, Undersized, and Special Motor Applications

The ATV58 *TRX* drive controller can be used in applications with multiple motors wired in parallel, undersized motors, or with special motors. To configure the drive controller for these applications, follow these steps:

1. Select either the “Hdg: Material Handling” or “GEn: General Use” macro-configuration (see page 23).
2. Configure the Special Motor parameter (SPC) in the Drive menu to Yes or PSM (see page 50).
3. Adjust the IR Compensation parameter (UFr) in the 2—Adjust menu to obtain satisfactory performance (see pages 35 and 37).

Parallel motor applications consist of multiple motors wired in parallel to the output of one drive controller. Refer to the Square D Application Guide, *Product Data Bulletin SC100R5/95*, available at [www.SquareD.com](http://www.SquareD.com) for information on properly sizing the drive controller for parallel motor applications.

An undersized motor is defined as a motor with a full current rating is less than 25% of the ATV58 *TRX* drive controller rating. Select *PSM* in the Special Motor menu.

Synchronous permanent magnet, synchronous wound field, and synchronous reluctance motors are examples of special motors.

Table 11 on page 43 shows the parameters accessed in the Drive menu.

# Menu 3

**Table 11: 3—Drive Menu Parameters**

Parameter	Code	Description	Adjustment Range	Factory Setting
Nom.Mot.Volt- V	UnS	Motor nameplate nominal voltage. <ul style="list-style-type: none"> <li>• ATV58••••M2</li> <li>• ATV58••••N4</li> </ul>	200 to 240 V 200 to 500 V	230 V or 400/460 V [1]
Nom.Mot.Freq - Hz	FrS	Motor nameplate nominal frequency.  The FrS setting defines the frequency at which nominal motor voltage (UnS) is applied to the motor. FrS cannot be set above the maximum output frequency setting tFr.	10 to tFr	50/60 Hz [1]
NonMotCurr.- A	nCr	Motor nameplate nominal current.	0.25 to 1.36 of In [2]	0.9 of In [2]
Nom.Mot.Speed -rpm	nSP	Motor nameplate nominal speed.  This should be the value that incorporates slip (i.e. this value should be the rpm of the motor when it is fully loaded).	0 to 9999 rpm	depends on drive controller rating

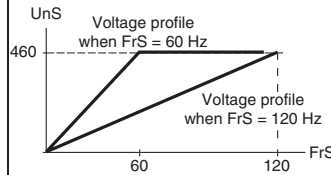

[1] Depending on the position of the 50/60 Hz switch. Ensure that the switch setting matches the input frequency (see page 14).  
 [2] In = drive controller constant torque output current rating shown on the drive controller nameplate.  
 [3] The factory setting depends on the macro-configuration used: No for Material Handling, Yes for General Use and Variable torque.  
 [4] This parameter is not available on 125–500 hp drive controllers.  
 [5] Refer to the drive controller instruction bulletin, VVDED397048US, for duty cycle ratings of the drive controllers.  
 ★ These parameters are available only with the I/O extension card installed.

# Menu 3

**Table 11: 3—Drive Menu Parameters** (continued)

Parameter	Code	Description	Adjustment Range	Factory Setting
Mot.CosPhi	CoS	<p>Motor CosPhi, motor power factor. Set the CoS parameter to the motor nameplate power factor.</p> <p>If the power factor is not provided on the nameplate or to optimize the motor torque performance, use the following procedure to optimize the motor power factor setting.</p> <p>Operate the motor with no load at a frequency equal to nominal frequency / 2. Then adjust the CoS parameter such that the measured motor voltage equals nominal motor voltage / 2.</p> <p>For example: For a 460 Vac motor operating at 60 Hz, adjust the CoS parameter to have 230 V at 30 Hz. If motor voltage is less than 230 V, decrease CoS parameter. If motor voltage is more than 230 V, increase the CoS parameter.</p>	0.5 to 1	depends on drive controller rating

[1] Depending on the position of the 50/60 Hz switch. Ensure that the switch setting matches the input frequency (see page 14).

[2]  $I_n$  = drive controller constant torque output current rating shown on the drive controller nameplate.

[3] The factory setting depends on the macro-configuration used: No for Material Handling, Yes for General Use and Variable torque.

[4] This parameter is not available on 125–500 hp drive controllers.

[5] Refer to the drive controller instruction bulletin, VVDED397048US, for duty cycle ratings of the drive controllers.

★ These parameters are available only with the I/O extension card installed.

# Menu 3

**Table 11: 3—Drive Menu Parameters** (continued)

Parameter	Code	Description	Adjustment Range	Factory Setting
Auto Tuning	tUn	<p>Initiates an autotune when the tUn parameter is set to Yes.</p> <p>After the autotune is complete, the display will show “done”. No is displayed if the autotune was not successful or completed.</p> <p>No is also displayed if the motor rating is less than 25% of drive controller I<sub>n</sub> rating or if multiple motors are connected. The CoS parameter may need to be manually adjusted for optimum performance.</p> <p>This feature will not work if any logic inputs are activated. If freewheel stop or fast stop are assigned to a logic input, they must be in the high state to autotune.</p> <p>When initiated, the drive controller pulses the connected motor, measures, and stores specific motor stator resistance and resistance of the conductors. This allows the drive controller to provide better current regulation for better motor torque performance. This can be initiated from the keypad display or by a logic input assigned to this function.</p>	No - Yes	No
Max.Freq. - Hz	tFr	Maximum output frequency. The maximum value is a function of the switching frequency (SFr, see page 50).	10 to 500 Hz	60/72 Hz <sup>[1]</sup>

## CAUTION

### MACHINERY OVERSPEED

Some motors and/or loads may not be suited for operation above nameplate motor speed and frequency. Consult the motor manufacturer before operating motor above rated speed.

**Failure to follow this instruction can result in injury or equipment damage.**

<sup>[1]</sup> Depending on the position of the 50/60 Hz switch. Ensure that the switch setting matches the input frequency (see page 14).

<sup>[2]</sup> I<sub>n</sub> = drive controller constant torque output current rating shown on the drive controller nameplate.

<sup>[3]</sup> The factory setting depends on the macro-configuration used: No for Material Handling, Yes for General Use and Variable torque.

<sup>[4]</sup> This parameter is not available on 125–500 hp drive controllers.

<sup>[5]</sup> Refer to the drive controller instruction bulletin, VVDED397048US, for duty cycle ratings of the drive controllers.

★ These parameters are available only with the I/O extension card installed.

# Menu 3

**Table 11: 3—Drive Menu Parameters** (continued)

Parameter	Code	Description	Adjustment Range	Factory Setting
Energy Eco	n L d	Optimizes the motor efficiency by automatically adjusting the Volts/Hz ratio. <i>NOTE: Energy Eco. is available only in variable torque mode.</i>	No - Yes	Yes
I Limit adapt.	F d b	Current limit adaptation. When configured for Yes, the current limit setting will increase as a function of output frequency. <i>NOTE: I Limit is available only in variable torque mode.</i>	No - Yes	No
DecRampAdapt	b r A	Activation allows the deceleration ramp time to be automatically increased, avoiding an overbraking fault (ObF) if the ramp time was too short.  This function may be incompatible with ramp positioning and with dynamic braking.  If relay R2 is assigned to Brake Logic, brA can only be set to No.	No - Yes	No <sup>[3]</sup>
SwitchRamp2- Hz	F r t	Frequency for ramp switching. When the output frequency is greater than Frt, the ramp times will be AC2 and dE2.	0 to HSP	0 Hz

<sup>[1]</sup> Depending on the position of the 50/60 Hz switch. Ensure that the switch setting matches the input frequency (see page 14).

<sup>[2]</sup>  $I_n$  = drive controller constant torque output current rating shown on the drive controller nameplate.

<sup>[3]</sup> The factory setting depends on the macro-configuration used: No for Material Handling, Yes for General Use and Variable torque.

<sup>[4]</sup> This parameter is not available on 125–500 hp drive controllers.

<sup>[5]</sup> Refer to the drive controller instruction bulletin, VVDED397048US, for duty cycle ratings of the drive controllers.

★ These parameters are available only with the I/O extension card installed.

# Menu 3

**Table 11: 3—Drive Menu Parameters** *(continued)*

Parameter	Code	Description	Adjustment Range	Factory Setting
Type of stop	Stt	<p>Type of stop:</p> <p>When a stop is requested, the type of stop defined by this parameter is activated until the FFt threshold (2—Adjust menu) is reached. Below this threshold, freewheel stop is activated.</p> <ul style="list-style-type: none"> <li>• Stn: On decel ramp</li> <li>• Fst: Fast stop</li> <li>• Nst: Freewheel stop</li> <li>• Dci: DC injection stop</li> </ul> <p><i>NOTE: Switch Ramp 2 is not available if LI is assigned to ramp switching.</i></p> <p><i>NOTE: This parameter, Stt, cannot be accessed if the R2 relay or a logic output is assigned to the "BLC: Brake Logic" function.</i></p>	STN–FST NST–DCI	STN

<sup>[1]</sup> Depending on the position of the 50/60 Hz switch. Ensure that the switch setting matches the input frequency (see page 14).

<sup>[2]</sup>  $I_n$  = drive controller constant torque output current rating shown on the drive controller nameplate.

<sup>[3]</sup> The factory setting depends on the macro-configuration used: No for Material Handling, Yes for General Use and Variable torque.

<sup>[4]</sup> This parameter is not available on 125–500 hp drive controllers.

<sup>[5]</sup> Refer to the drive controller instruction bulletin, VVDED397048US, for duty cycle ratings of the drive controllers.

★ These parameters are available only with the I/O extension card installed.

# Menu 3

Table 11: 3—Drive Menu Parameters (continued)

Parameter	Code	Description	Adjustment Range	Factory Setting
Ramp Type	r P L	<p>Defines the type of acceleration and deceleration ramps.</p> <p>LIN: linear S: S ramp U: U ramp</p>	LIN - S - U	LIN
DecRamp Coeff	d C F	<p>Coefficient for reducing the deceleration ramp time when a logic input has been assigned to the Fast Stop function.</p> <p>For example: If dec=20 s, setting dCF to 2 results in a 10 s dec ramp setting.</p>	1 to 10	4

NOTE: DecRamp Coeff is only available if fast stop is enabled.

- [1] Depending on the position of the 50/60 Hz switch. Ensure that the switch setting matches the input frequency (see page 14).
  - [2]  $I_n$  = drive controller constant torque output current rating shown on the drive controller nameplate.
  - [3] The factory setting depends on the macro-configuration used: No for Material Handling, Yes for General Use and Variable torque.
  - [4] This parameter is not available on 125–500 hp drive controllers.
  - [5] Refer to the drive controller instruction bulletin, VVDED397048US, for duty cycle ratings of the drive controllers.
- ★ These parameters are available only with the I/O extension card installed.



# Menu 3

NOTE: Mot P Coef. is only available if motor switching is enabled.

NOTE: Modifying SFt causes the following parameters to revert to factory settings:  
3—Drive Menu:  
nCr, CLl, SFr, nrd  
2—Adjust Menu:  
itH, IdC, lbr, Ctd

Table 11: 3—Drive Menu Parameters (continued)

Parameter	Code	Description	Adjustment Range	Factory Setting
Trq.Limit1 -% [4]	ELI	Torque limit allows limitation of the maximum motor torque.	0 to 200% torque	200%
Int.I Lim -A	CLI	Current limit used to limit the maximum motor heating.	0 to 1.36 of I <sub>n</sub> [2]	1.36 of I <sub>n</sub> [2]
Auto DC Inj.	AdC	Allows deactivation of automatic DC injection at stop.	No - Yes	Yes
Mot P Coef.	PLC	Defines the ratio between the nominal drive controller power and the motor with the lowest power rating when a logic input is assigned to the motor switching function (see page 71).	0.2 to 1	1
Sw. Freq. Type	SFE	Allows selection of the type of switching frequency.  <ul style="list-style-type: none"> <li>LF allows adjustment between 0.5 and 4 kHz using the SFr parameter.</li> <li>HF1 and HF2 allow adjustment between 4 and 16 kHz: HF1 is for applications with a low duty cycle, without derating the drive controller. If the drive controller thermal state goes above 95%, the switching frequency automatically goes to 2 or 4 kHz (depending on rating). When the thermal state returns to 70%, the switching frequency returns to the set value.</li> <li>HF2 is for machines with a high duty cycle with derating of the drive controller by one power rating. The drive parameters (current limit, thermal current, etc.) are automatically scaled.</li> </ul>	LF - HF1 - HF2 [5]	LF

[1] Depending on the position of the 50/60 Hz switch. Ensure that the switch setting matches the input frequency (see page 14).

[2] I<sub>n</sub> = drive controller constant torque output current rating shown on the drive controller nameplate.

[3] The factory setting depends on the macro-configuration used: No for Material Handling, Yes for General Use and Variable torque.

[4] This parameter is not available on 125–500 hp drive controllers.

[5] Refer to the drive controller instruction bulletin, VVDED397048US, for duty cycle ratings of the drive controllers.

★ These parameters are available only with the I/O extension card installed.

# Menu 3

**Table 11: 3—Drive Menu Parameters (continued)**

Parameter	Code	Description	Adjustment Range	Factory Setting
Sw Freq -kHz	SFr	Selection of switching frequency. The range depends on the SFt parameter.  The maximum operational frequency (tFr) is limited depending on the switching frequency:  SFr (kHz) 0.5 1 2 4 8 12 16 tFr (Hz) 62 125 250 500 500 500 500	LF: 0.5-1-2-4 kHz HF1 or HF2: 4-8-12-16 kHz <sup>[5]</sup>	LF: 4 kHz HF1 or HF2: (depending on controller rating)
Noise Reduct.	nrd	This function randomly modulates the switching frequency in order to reduce audible motor noise.	No - Yes	Yes if SFt = LF No if SFt = HF1 or HF2
Special Mot.	SPC	Special motor adaptation  This parameter should be set to Yes when using special motors such as synchronous permanent magnet motors, synchronous wound field motors, or synchronous reluctance motors. This parameter should also be enabled if using one drive controller to control multiple motors in parallel. Installation of individual motor thermal protection is required when using the drive controller to control multiple motors in parallel.  The PSM setting is intended to be used when the motor connected to the drive controller is less than 25% of the drive controller's nominal current rating. It may be necessary to disable output phase loss protection, OPL. Installation of motor thermal protection is required in this type of application.  Also, the PSM setting can be enabled to allow for open circuit output voltage testing.  Enabling the SPC parameter increases the IR compensation adjustment range from 0 to 800%.	No - Yes - PSM	No

*NOTE: Special Mot. is not available in variable torque mode except in the 125–500 hp drive controllers. After enabling this parameter, the IR compensation parameter appears in Menu 2. For 1/2–100 hp drive controllers, setting SPC to PSM while in the material handling macro and then selecting the variable torque macro will leave the PSM setting enabled.*

<sup>[1]</sup> Depending on the position of the 50/60 Hz switch. Ensure that the switch setting matches the input frequency (see page 14).  
<sup>[2]</sup> I<sub>n</sub> = drive controller constant torque output current rating shown on the drive controller nameplate.  
<sup>[3]</sup> The factory setting depends on the macro-configuration used: No for Material Handling, Yes for General Use and Variable torque.  
<sup>[4]</sup> This parameter is not available on 125–500 hp drive controllers.  
<sup>[5]</sup> Refer to the drive controller instruction bulletin, VVDED397048US, for duty cycle ratings of the drive controllers.  
★ These parameters are available only with the I/O extension card installed.

# Menu 3

**Table 11: 3—Drive Menu Parameters** *(continued)*

Parameter	Code	Description	Adjustment Range	Factory Setting
PG Type ★	PGE	Defines the type of sensor used when an encoder feedback I/O card is installed. INC: incremental encoder (A, A+, B, B+ are wired). DET Detector (only A is wired).	INC-DET	DET
Num. Pulses ★	PL5	Defines the number of pulses for each revolution of the sensor.	1 to 1024	1024

[1] Depending on the position of the 50/60 Hz switch. Ensure that the switch setting matches the input frequency (see page 14).

[2]  $I_n$  = drive controller constant torque output current rating shown on the drive controller nameplate.

[3] The factory setting depends on the macro-configuration used: No for Material Handling, Yes for General Use and Variable torque.

[4] This parameter is not available on 125–500 hp drive controllers.

[5] Refer to the drive controller instruction bulletin, VVDED397048US, for duty cycle ratings of the drive controllers.

★ These parameters are available only with the I/O extension card installed.

4—Control Menu

The Control Menu is accessible when the access locking switch is in the total unlock, , position. The parameters can only be modified when the motor is stopped.

**Table 12: 4—Control Menu: Keypad Display or 2- and 3-Wire Control**

**Menu  
4**

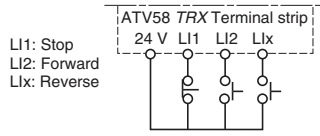
Parameter	Code	Description	Adjustment Range	Factory Setting																										
TermStripCon.	E C C	Configuration of the terminal strip command: 2- or 3-wire control.	2W - 3W	2W																										
		<p><i>NOTE: Modification of this parameter requires two confirmations since it causes a reassignment of the logic inputs. Shown below are the LI assignments when 3-wire control is selected. See Table 3 on page 24 for the assignments in 2-wire control. In 3-wire control, LI1 and LI2 cannot be reassigned.</i></p> <table border="1"> <thead> <tr> <th>I/O</th> <th>Material Handling</th> <th>General Use</th> <th>Variable Torque</th> </tr> </thead> <tbody> <tr> <td>LI1</td> <td>STOP</td> <td>STOP</td> <td>STOP</td> </tr> <tr> <td>LI2</td> <td>Run forward</td> <td>Run forward</td> <td>Run forward</td> </tr> <tr> <td>LI3</td> <td>Run reverse</td> <td>Run reverse</td> <td>Run reverse</td> </tr> <tr> <td>LI4</td> <td>2 Preset speeds</td> <td>Jog</td> <td>Reference switching <sup>[1]</sup></td> </tr> <tr> <td>LI5★</td> <td>4 Preset speeds</td> <td>Freewheel stop</td> <td>Injection braking <sup>[1]</sup></td> </tr> <tr> <td>LI6★</td> <td>8 Preset speeds</td> <td>Clear faults</td> <td>Freewheel stop <sup>[1]</sup></td> </tr> </tbody> </table> <p><b>Selecting 3-wire control inhibits the automatic restart function.</b></p> <p>3-wire control wiring example:</p>  <p>★ These I/O can be accessed if an I/O extension card has been installed.</p> <p><sup>[1]</sup> For 125–500 hp drive controllers the factory setting are: LI4 = Fault Reset; LI5 = ramp switching; LI6 = Not assigned</p>	I/O	Material Handling	General Use	Variable Torque	LI1	STOP	STOP	STOP	LI2	Run forward	Run forward	Run forward	LI3	Run reverse	Run reverse	Run reverse	LI4	2 Preset speeds	Jog	Reference switching <sup>[1]</sup>	LI5★	4 Preset speeds	Freewheel stop	Injection braking <sup>[1]</sup>	LI6★	8 Preset speeds	Clear faults	Freewheel stop <sup>[1]</sup>
I/O	Material Handling	General Use	Variable Torque																											
LI1	STOP	STOP	STOP																											
LI2	Run forward	Run forward	Run forward																											
LI3	Run reverse	Run reverse	Run reverse																											
LI4	2 Preset speeds	Jog	Reference switching <sup>[1]</sup>																											
LI5★	4 Preset speeds	Freewheel stop	Injection braking <sup>[1]</sup>																											
LI6★	8 Preset speeds	Clear faults	Freewheel stop <sup>[1]</sup>																											

# Menu 4

NOTE: Type 2 Wire appears only if 2-wire control is selected.

Table 13: 4—Control Menu: 2-Wire Control Type

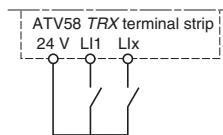
Parameter	Code	Description	Adjustment Range	Factory Setting
Type 2 Wire	ELL	<p>Defines the type of 2-wire control:</p> <ul style="list-style-type: none"> <li>LEL: If the forward or reverse input is high when the drive controller is powered up, the drive controller will start the motor. If both inputs are high on power up, the controller will run forward.</li> <li>TrN: The drive controller must see a transition from low to high of the forward or reverse input before it will start the motor. Therefore, if the forward or reverse input is high when the drive controller is powered up, the input must be cycled before the drive controller will start the motor.</li> <li>PFW: Forward input has priority over reverse input with this control. If forward is activated while the controller is running in reverse, the controller will run forward.</li> </ul> <p>2-wire control wiring example:</p> 	LEL-TrN-PFW	LEL
RV inhibit	rln	<p>When configured for Yes, this function inhibits reverse operation even if reverse operation is requested by a summing or PI regulator function.</p> <p>This parameter is not available if a logic input is configured for reverse. A logic input cannot be configured for reverse if this parameter is configured for Yes.</p>	Yes - No	No

★ These I/O can be accessed if an I/O extension card has been installed.

[1] For 125–500 hp drive controllers the factory setting are:  
LI4 = Fault Reset; LI5 = ramp switching; LI6 = Not assigned

# Menu 4

**Table 13: 4—Control Menu: 2-Wire Control Type**

Parameter	Code	Description	Adjustment Range	Factory Setting
deadb./Pedst.	bSP	<p>This function can be used to manage low speed operation.</p> <p>The first graph shows a linear ramp from LSP to HSP as speed reference goes from 0 to 100%, with the label 'No'.  The second graph shows a linear ramp from LSP to HSP, but with a horizontal segment at LSP from 0 to a certain point, labeled 'Pedestal (BNS)'.  The third graph shows a linear ramp from LSP to HSP, but with a horizontal segment at LSP from 0 to a certain point, labeled 'Deadband (BLS)'.</p>	No BLS BnS	No

★ These I/O can be accessed if an I/O extension card has been installed.

[1] For 125–500 hp drive controllers the factory setting are:  
LI4 = Fault Reset; LI5 = ramp switching; LI6 = Not assigned

# Menu 4

*NOTE: If CRL is set higher than CRH, reverse sense operation will result (i.e., 20 mA will equal low speed and 4 mA will equal high speed).*

**Table 14: 4—Control Menu: Other Parameters**

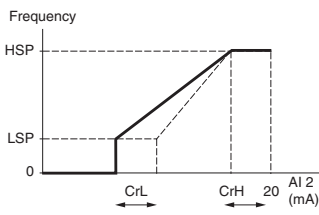
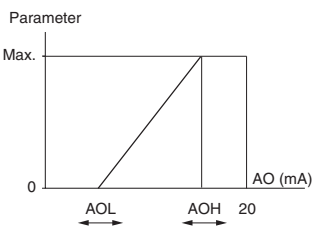
Parameter	Code	Description	Adjustment Range	Factory Setting
AI2 min Ref.-mA AI2 Max. Ref.-mA	<i>C r L</i> <i>C r H</i>	<ul style="list-style-type: none"> <li>CrL: Minimum value of the signal on analog input AI2</li> <li>CrH: Maximum value of the signal on analog input AI2</li> </ul> <p>These two parameters allow definition of the signal at AI2. The input can be configured for 0–20 mA, 4–20 mA, 20–4 mA, among other possibilities.</p> 	CrL: 0–20 mA CrH: 4–20 mA	CrL: 4 mA CrH: 20 mA
AO min Val.-mA AO Max. Val.-mA	<i>A O L</i> <i>A O H</i>	<p>Min. value of the signal on output AO</p> <p>Max. value of the signal output on AO</p> <p>These two parameters are used to define the output signal on AO.</p> <p>For example: 0–20 mA, 4–20 mA, 20–4 mA, etc.</p> 	0–20 mA 0–20 mA	0 mA 20 mA

★ These parameters are available only with the I/O extension card installed.

# Menu 4

Table 14: 4—Control Menu: Other Parameters

Parameter	Code	Description	Adjustment Range	Factory Setting
Save Ref	S E r	This function allows saving the reference, either when the run command is removed (RAM) or when mains power is removed (EEP). When the motor is next started, the reference speed will be the last saved reference. In order for speed reference to be saved in EEP mode, the run command cannot be present when re-applying power. <i>NOTE: Save Reference is only available if LIs are assigned to +Speed/-Speed.</i>	NO-RAM-EEP	NO
KeypadCon.	L C C	Allows command of the drive controller via the keypad display. The STOP/RESET, RUN, and FWD/REV keys are active. The reference speed is given by the LFr or LCU parameter (see page 30). <b>Only the freewheel stop, fast stop, and stop by DC injection commands remain active at the terminal strip.</b> If the link between the drive controller and keypad display is lost, the drive controller will trip on the SLF fault (serial link fault). If this parameter is set to YES prior to the request to return to Factory Settings, it will remain set to YES after returning to Factory Settings.	No - Yes	No

★ These parameters are available only with the I/O extension card installed.



# Menu 4

**Table 14: 4—Control Menu: Other Parameters**

Parameter	Code	Description	Adjustment Range	Factory Setting
Stop Priorit.	PSt	<p>This function gives priority to the STOP key on the keypad display no matter what the command source (terminal strip, keypad display, or serial link).</p> <p>To change the PSt parameter to No:</p> <ol style="list-style-type: none"> <li>1. Display no.</li> <li>2. Press ENT.</li> <li>3. The drive controller displays “See manual”.</li> <li>4. Press the up arrow key, then the down arrow key, then ENT, then ESC.</li> </ol> <p><b>When this parameter is set to No, the stop key on the keypad display will be inactive.</b> To return to Yes, display Yes then press enter.</p>	No - Yes	Yes

## ⚠ WARNING

### DISABLED STOP COMMAND

Disabling the stop key on the keypad display will prevent the drive controller from stopping when the stop key is pressed. An external stop command must be installed to stop the motor.

**Failure to follow this instruction can result in death, serious injury, or equipment damage.**

DriveAddress	Addr	Drive controller address controlled through the RS-485 port by a MODBUS device (i.e., without the programming or operating keypad display). If this parameter is set to any numeral other than 0 prior to the request to return to Factory Settings, it will remain set to that numeral after returning to Factory Settings.	0 to 31	0
--------------	------	--	---------	---

★ These parameters are available only with the I/O extension card installed.

# Menu 4

**Table 14: 4—Control Menu: Other Parameters**

Parameter	Code	Description	Adjustment Range	Factory Setting
BdRate RS485	E b r	<p>Transmission speed on the RS-485 MODBUS port on the front of the drive controller.</p> <ul style="list-style-type: none"> <li>9600 Bits / second</li> <li>19200 Bits / second</li> </ul> <p><i>NOTE: The keypad display will not operate properly if parameter tbr is set to 9600. On power up, ERR7 may show on the display indicating this error.</i></p> <p><i>To reset:</i></p> <ol style="list-style-type: none"> <li>Turn off power to the drive controller.</li> <li>Slide the 50/60 Hz switch to the direction opposite its current position.</li> <li>Power up the drive controller for 3 s.</li> <li>Repeat Step 1.</li> <li>Slide the 50/60 Hz switch to its original position.</li> <li>Power up the drive controller and reenter the correct user configuration, because the parameters will have returned to their factory settings.</li> </ol>	9600, 19200	19200
Reset counters	r P r	<p>This parameter sets KWh or operating time to 0.</p> <p>No: Ready to accept a reset command.                      APH: KWh reset to 0                      RTH: Operating time reset to 0</p> <p>Press "ENT" to confirm the reset to 0 command.                      APH and RTH are active immediately. The parameter then automatically returns to No.</p>	No-APH-RTH	No

★ These parameters are available only with the I/O extension card installed.

## 5—I/O Menu

This menu allows you to assign functions to the inputs and outputs. It is accessible when the access locking switch is in the total unlock, , position. The I/O assignments can only be modified if the motor is not running.

The inputs and outputs displayed in the I/O menu vary depending on selections made in the 4—Control menu and whether or not an I/O extension card is installed. On the 125–500 hp drive controllers, the Brake Logic function and I/O associated with torque are not configurable. The default settings depend on the macro-configuration selected (see Table 3 on page 24 for factory settings).

Table 15 shows which functions can be assigned to the analog input and which can be assigned to a logic input. Additional inputs are available and can be assigned when an I/O extension card is installed. *L11 and R1 cannot be reassigned. AI1, L11, and R1 are not displayed in the I/O menu.*

**Table 15: Possible Assignments for Configurable Inputs**

I/O Extension Card		2 Logic Inputs LI5-LI6	Analog Input AI3	Logic Input [1] A, A-, B, B-	
<b>Drive Controller without an I/O Extension Card</b>					
Code and Parameter	Description	Analog Input AI2	3 Logic Inputs LI2-LI4		
NO: Not assigned	Not assigned	X	X	X	X
RV: Reverse	Run reverse		X		
RP2: Switch ramp2	Ramp switching		X		
JOG	Jog		X		
+SP: + Speed	+Speed		X		
-SP: - Speed	-Speed		X		
PS2: 2 Preset Sp	2 preset speeds		X		
PS4: 4 Preset Sp	4 preset speeds		X		
PS8: 8 Preset Sp	8 preset speeds		X		
NST: Freewhl Stop	Freewheel stop/run permissive		X		
DCI: DC inject	DC injection braking		X		
FST: Fast stop	Fast stop		X		
CHP: Multi.Motor	Switching between two motors		X		
TL2: Torque Lim2 [2]	Second torque limit		X		
FLO: Forced Local	Force to local		X		
RST: Fault Reset	Fault reset		X		
RFC: Auto/Manu	Reference switching		X		

[1] The menu for assigning encoder input A, A-, B, B- is called "Assign AI3".

[2] This parameter is not available on 125–500 hp drive controllers.

[3] An AI for PIF (PI regulator) cannot be configured if RFC (Auto/manual) is already assigned to a logic input. For more details refer to page 74.

# Menu 5

*NOTE: When reassigning inputs from +Speed and -Speed, reassign -Speed first.*

*When reassigning inputs from preset speeds, reassign PS8 first, then PS4, then PS2.*

# Menu 5

**Table 15: Possible Assignments for Configurable Inputs**

I/O Extension Card		2 Logic Inputs LI5-LI6	Analog Input AI3	Logic Input <sup>[1]</sup> A, A-, B, B-
Drive Controller without an I/O Extension Card		Analog Input AI2	3 Logic Inputs LI2-LI4	
Code and Parameter	Description			
ATN: Autotune	Auto-tuning		X	
PIF: PI regulator	PI regulator feedback	X <sup>[3]</sup>		X <sup>[3]</sup>
PAU:PI Auto/Man	PI Auto/manual if one AI is assigned to PIF		X	
PIM:PI Man.ref.	Manual PI speed reference if one AI is assigned to PIF			X
PR2:PI 2 Preset	2 preset PI setpoints if one AI is assigned to PIF		X	
PR4:PI 4 Preset	4 preset PI setpoints if one AI is assigned to PIF		X	
EDD:Ext. flt	External fault input		X	
TLA:Torque limit <sup>[2]</sup>	Torque limitation by AI if one AI is assigned to ATL		X	
FR2: Speed Ref2	Speed reference 2	X		
SRI: Summed Ref.	Reference summing	X		X
SFB: Tacho feedbk	Tachogenerator			X
PTC: Therm. Sensor	PTC probes			X
ATL: Torque Lim. <sup>[2]</sup>	Analog Torque limit			X
RGI: PG feedbk	Encoder or sensor feedback			X

<sup>[1]</sup> The menu for assigning encoder input A, A-, B, B- is called "Assign AI3".

<sup>[2]</sup> This parameter is not available on 125–500 hp drive controllers.

<sup>[3]</sup> An AI for PIF (PI regulator) cannot be configured if RFC (Auto/manual) is already assigned to a logic input. For more details refer to page 74.

# Menu 5

Table 16 shows which functions can be assigned to relay output R2, logic output LO, and analog output AO.

**Table 16: Possible Assignments for Configurable Outputs**

I/O Extension Card		Analog Output AO	Logic Output LO
Drive Controller without an I/O Extension Card		Relay R2	Analog Output AO1
NO: Not assigned	No assigned	X	X
RUN: DriveRunning	Drive controller running	X	
OCC: OutPut Cont.	Output contactor command	X	
FTA: Freq Attain.	Frequency threshold attained	X	
FLA: HSP Attained	High speed attained	X	
CTA: I Attained	Current level attained	X	
SRA: FRH Attained	Reference speed attained	X	
TSA: Mtr Therm Lvl	Motor thermal level attained	X	
tAd: ATU th. alarm	Drive thermal level attained	X	
APL:4-20 mA loss	Loss of 4-20 mA signal	X	
F2A:F2 Attained	Second frequency threshold reached	X	
BLC: Brk Logic <sup>[1]</sup>	Brake logic	X	
OCR: Motor current	Motor current		X
OFR: Motor Frequency	Motor speed		X
ORP: Output Ramp	Ramp output		X
TRQ: Motor torque <sup>[1]</sup>	Motor torque		X
STQ: Signed Torq. <sup>[1]</sup>	Signed motor torque		X
ORS: Signed ramp	Ramp output with +/- sign		X
OPS:PI ref.	PI setpoint output, if one AI is assigned to PIF		X
OPF:PI Feedback	PI feedback output, if one AI is assigned to PIF		X
OPE:PI Error	PI error output, if one AI is assigned to PIF		X

<sup>[1]</sup> These parameters are not available on 125-500 hp drive controllers.

# Menu 5

**Table 16: Possible Assignments for Configurable Outputs**

I/O Extension Card		Analog Output AO	Logic Output LO
Drive Controller without an I/O Extension Card		Relay R2	Analog Output AO1
OPI: PI Integral	PI integral output, if one AI is assigned to PIF		X
OPR: Motor Power	Motor power		X
THR: Motor Thermal	Motor thermal state		X
THD: Drive Thermal	Drive thermal state		X

<sup>[1]</sup> These parameters are not available on 125–500 hp drive controllers.

After the I/O have been assigned, additional parameters related to the functions automatically appear in the menus, and the macro-configuration is CUS: Customized. The additional parameters are listed in Tables 17 and 18.

**Table 17: New Parameters in 2—Adjust Menu After I/O Reassignment**

# Menu 2

I/O	Assignment	New Parameters to Adjust
LI	RP2 Ramp switching	<i>R C 2 d E 2</i>
LI	JOG Jog	<i>J O G J G t</i>
LI	PS4 4 preset speeds	<i>S P 2 S P 3</i>
LI	PS8 8 preset speeds	<i>S P 4 S P 5 S P 6 S P 7</i>
LI	DCI DC injection braking	<i>I D C</i>
LI	TL2 Second torque limit <sup>[1]</sup>	<i>t L 2</i>
LI	PR4 4 preset PI setpoints	<i>P I 2 - P I 3</i>
AI	PIF PI regulator	<i>r P G r I G F b 5 P I C</i>
AI	SFB Tachogenerator	<i>d t 5</i>
R2	BLC Brake logic <sup>[1]</sup>	<i>b r L l b r b r t b E n b E t</i>
R2, LO	FTA Frequency threshold attained	<i>F t d</i>
R2, LO	CTA Current threshold attained	<i>C t d</i>
R2, LO	TSA Motor thermal threshold attained	<i>t t d</i>

<sup>[1]</sup> These parameters are not available on 125–500 hp drive controllers.

# Menu 2

**Table 17: New Parameters in 2—Adjust Menu After I/O Reassignment**

I/O	Assignment	New Parameters to Adjust
R2, LO	TAD Drive thermal threshold attained	<i>d t d</i>
R2, LO	F2A 2nd frequency threshold reached	<i>F 2 d</i>

[1] These parameters are not available on 125–500 hp drive controllers.

**Table 18: New Parameters in Menus 3, 4, and 6 After I/O Reassignment**

I/O	Assignment	Parameters to Adjust
LI	-SP - Speed	<i>S t r</i> (4—Control menu)
LI	FST Fast stop	<i>d t F</i> (3—Drive menu)
LI	CHP Motor switching	<i>P t t</i> (3—Drive menu)
LI	RST Fault reset	<i>r t t</i> (6—Fault menu)
AI	SFB Tachogenerator	<i>S d d</i> (6—Fault menu)
A+, A-, B+, B-	SAI Summing reference	<i>P t t, P L 5</i> (3—Drive menu)
A+, A-, B+, B-	RGI Encoder feedback	<i>P t t, P L 5</i> (3—Drive menu)

**Figure 12: Function Compatibility Chart**

The compatibility of certain functions can limit the application functions which can be assigned. Figure 12 shows the incompatibilities between functions. The functions not listed in Figure 12 are compatible with all other functions.

	Automatic DC injection braking	Summing inputs	PI Regulator	+Speed/-Speed	Reference switching (Auto/manual)	PI regulator with Auto/manual	Freewheel stop	Fast stop	Jog	Preset Speeds	Reverse operation	Inhibit reverse operation	Speed regulation with tachogenerator or encoder	Torque limitation via AI3	Torque limitation via LI
Automatic DC injection braking	■						↑								
Summing inputs		■			●	●									
PI Regulator			■		●			●	●				●		
+Speed/-Speed				■	●	●		↑	●						
Reference switching (Auto/manual)		●	●	●	■	●			●						
PI regulator with Auto/manual		●		●	●	■									
Freewheel stop	←						■	←							
Fast stop							↑	■							
Jog			●	←				■	←						
Preset Speeds			●	●	●			↑	■						
Reverse operation										■	●				
Inhibit reverse operation										●	■				
Speed regulation with tachogenerator or encoder			●									■		●	
Torque limitation via AI3													●	■	
Torque limitation via LI															■

- Incompatible functions
- Compatible functions
- No significance

Function priority (functions which cannot be active at the same time):

← ↑ The arrow points to the function that has priority.

The stop functions have priority over run commands.  
The speed references from a logic command have priority over analog references.

*Note: An incompatible function must be deselected before the desired function can be programmed. For example, if preset speeds is programmed, it must be cleared before the +/- speed parameter can be selected.*



## Using the Logic Inputs

### Run Forward and Run Reverse

The logic input used for run reverse can be reassigned if the application has only one rotation direction.

### 2-wire Control

In 2-wire control, run (forward or reverse) and stop are commanded by the same logic input. When the logic input is closed (set to state 1), run is commanded. When it is opened (set to state 0), stop is commanded. See tCt on page 53 for more information.

## WARNING

### UNINTENDED EQUIPMENT OPERATION

LI1 has priority:

- If LI1 is closed while LI2 is active, the controller will respond to LI1.
- If the LI1 input is lost while LI2 is active, the controller will respond to LI2 and reverse directions.

The logic inputs must be programmed appropriately for the application to prevent the motor from spinning in an unintended direction.

**Failure to follow this instruction can result in death, serious injury, or equipment damage.**

### 3-wire Control

In 3-wire control, run (forward or reverse) and stop are commanded by two different logic inputs. LI1 is always assigned to stop which is obtained by opening LI1 (setting it to state 0). A pulse on the run input is saved until the stop input is opened.

Whenever the drive controller is powered up or reset, the motor will only run after resetting the Forward, Reverse, and DC injection inputs.

## Ramp Switching

This function allows switching between the first and second ramps. The first ramps are ACC and dEC, the second ramps are AC2 and dE2. There are two ways to activate the function:

- Assign a logic input to RP2 and close the assigned input (set it to state 1).
- By detection of a frequency threshold. This must be configured with the Frt parameter.

If a logic input is assigned to the function, ramp switching can only be initiated by the assigned input.

## Jog

A logic input can be assigned to the Jog function to define a motor speed from 0 to 10 Hz. A run command (FWD or REV) is also required.

If the Jog contact is closed (set to state 1) and then a run command is given:

- The acceleration ramp is 0.1 s.
- The deceleration ramp will be 0.1 s when the run command is removed.

If a run command is given and then the Jog contact is closed (set to state 1):

- The acceleration ramp (ACC) is 0.1 s if the motor speed is less than the programmed Jog speed.
- The deceleration ramp (dEC) is followed if the motor speed is higher than the programmed Jog speed.

When the Jog contact is opened (set to state 0), the ACC and dEC settings are used to adjust the motor speed.

The following Jog parameters can be modified in the 2—Adjust menu:

- Jog speed (JOG)
- Delay between jog pulses (JGt)

## +Speed/-Speed

There are two types of operation for +Speed/-Speed:

1. Use of pushbuttons. Two logic inputs are required in addition to the run direction inputs. The +Speed input increases the speed

and the -Speed input decreases the speed. If logic inputs are assigned to +Speed/-Speed, the Str parameter appears in the 4—Control menu allowing the reference speed to be saved (see page 56).

*NOTE: When 3-wire control is selected, -Speed is automatically assigned to the next input after the one assigned to +Speed.*

2. Use of selector switches. Only one logic input, assigned to +Speed, is required. When using selector switches, there is one position for each rotation direction.

*NOTE: This type of operation is not compatible with 3-wire control.*

The Save Reference (Str) parameter can be used to save the last speed reference when the run command is removed or when the power is removed.

In both types of operations, the maximum speed is set by the reference speeds at the analog inputs. For example, if 60 Hz is the desired maximum speed, a jumper can be installed from +10 Vdc to AI1.

Figures 13 and 14 illustrate wiring and timing for +Speed/-Speed.

**Figure 13: +Speed / -Speed Wiring Diagram**

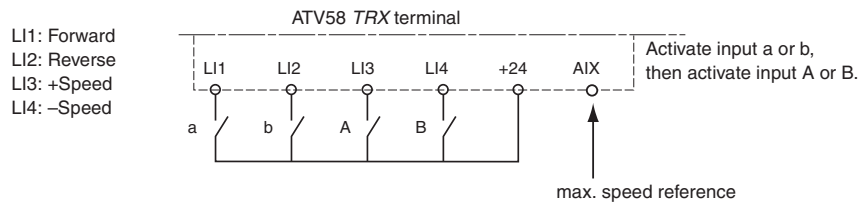

**Figure 14: +Speed/-Speed Timing Diagram**

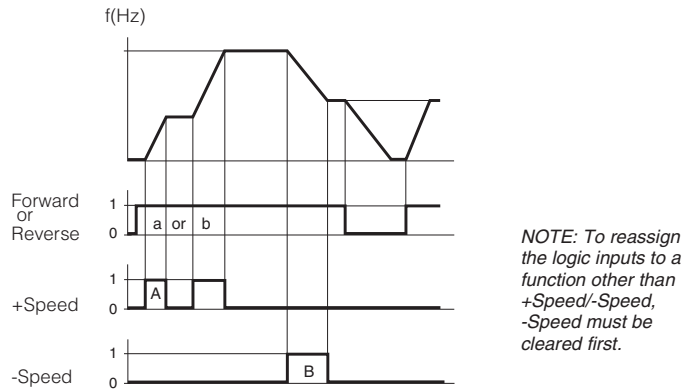

Figures 15 and 16 show a wiring example and a timing diagram for +Speed using selector switches. This function requires a maximum speed reference input. For example, if 60 Hz is the desired maximum speed, a jumper can be installed from +10 Vdc to AI1.

**Figure 15: Wiring Example for +Speed (Selector Switches)**

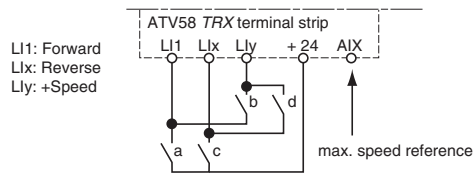
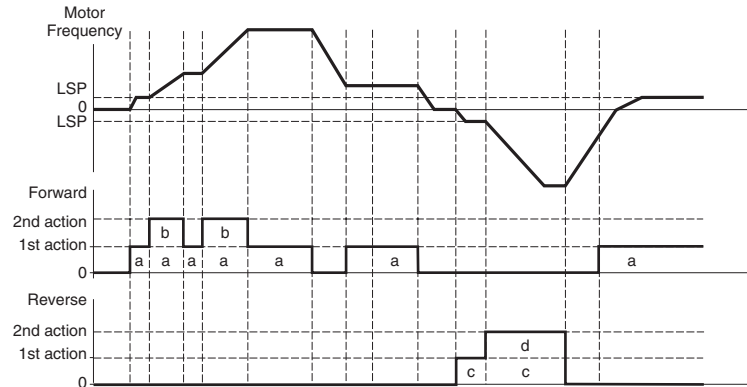

Figure 16: +Speed Timing Diagram (Selector Switches)



Preset Speeds

2, 4, or 8 speeds can be preset, requiring 1, 2, or 3 logic inputs, respectively.

Table 19 shows how the logic inputs are configured for Preset Speeds and the input states that activate them.

Table 19: Preset Speed Logic

2 Preset Speeds		4 Preset Speeds			8 Preset Speeds			
Assign Llx to PS2.		Assign Llx to PS2, then Lly to PS4.			Assign Llx to PS2, then Lly to PS4, then Liz to PS8.			
Llx	Speed reference	Lly	Llx	Speed reference	Liz	Lly	Llx	Speed reference
0	LSP + AI reference	0	0	LSP + AI reference	0	0	0	LSP + AI reference
1	HSP	0	1	SP2	0	0	1	SP2
		1	0	SP3	0	1	0	SP3
		1	1	HSP	0	1	1	SP4
		1	0		1	0	0	SP5
		1	0		1	0	1	SP6
		1	1		1	1	0	SP7
		1	1		1	1	1	HSP

NOTE: To reassign the logic inputs to a function other than Preset Speeds, PS8 (Liz) must be cleared, then PS4 (Lly), then PS2 (Llx).

### Reference Switching (Auto/Manual)

Switching between two references (at AI1 and AI2) by a logic input command. When the logic input is closed (set to state 1), AI1 is enabled. This function automatically assigns AI2 to Speed Reference 2.

**Figure 17: Reference Switching Wiring Diagram**

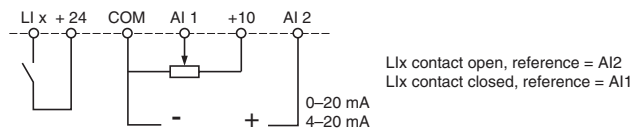

### Freewheel Stop (Coast to Stop) / Run Permissive

A logic input can be assigned to the Freewheel Stop / Run Permissive (NST) function. *The drive controller will not run until the logic input is closed.* Opening the logic input assigned to the function (setting it to state 0) causes the drive controller to stop applying power to the motor and the motor to coast to a stop. When the logic input is open, NST is displayed in the Drive state screen on the keypad display to indicate that a freewheel stop has been requested. The drive controller will not run until the logic input is closed. This can be used with the Forced Local function for drive controllers on communication networks.

A freewheel stop can be used with a stop command and by setting the FFt parameter. When a stop command is given and the frequency drops below the frequency set with the FFt parameter, the drive controller will freewheel stop.

### DC Injection Braking

DC injection braking can be activated at the end of each stop cycle (Adc = Yes) or DC injection braking can be obtained by closing the logic input assigned to the DC Injection Braking function (setting it to state 1).

## Fast Stop

### **WARNING**

#### **EXTENDED STOPPING TIME**

- Deceleration time during fast stop may be automatically extended depending on the braking ability of the drive controller.
- A dynamic brake or mechanical stopping/holding brake may be required for consistent stopping times independent of motor load conditions.
- Fast stop does not function during loss of power or drive controller fault.

**Failure to follow these instructions can result in death, serious injury, or equipment damage.**

Fast stop is a braked stop with the deceleration ramp time reduced by a programmable coefficient (see dCF on page 48). Fast stop is obtained by opening the logic input assigned to the function (setting it to state 0), or by configuring fast stop (Fst: Fast Stop) under type of stop (Stt on page 47).

## Motor Switching

This function allows a single drive controller to control two motors with different power ratings, one at a time. The ratio between the motor power ratings is set with the PCC parameter in the 3—Drive menu (see page 49).

If the two motors have different power ratings, enclosure types, or speed ratings, then separate motor contactors, thermal protection, and short circuit protection will be required for each motor. **This function automatically inhibits motor thermal protection of the second motor.**

The motor switching command will not be taken into account unless the motor is stopped. If the output contactor opens while the motor is running, the drive controller may trip on overcurrent or overvoltage which may result in damage to the drive controller. The following

parameters are automatically scaled by the command from the logic input:

- DC injection current
- Brake release current
- Nominal motor current

#### Second Torque Limit

Second Torque Limit reduces the maximum motor torque when the logic input is closed (state set to 1). Use the 2—Adjust menu to configure the percentage of torque.

#### Fault Reset

Fault reset erases a saved fault and resets the drive controller if the cause of the fault has disappeared. Two types of reset are possible: partial or total. This is set by the rSt parameter in the 6—Fault menu. For a partial reset (rSt = RSP), the following faults are reset and cleared from the display:

- input line overvoltage
- motor overload
- motor overheating
- overbraking
- network communication fault
- loss of RS-485 port communication
- motor phase loss
- loss of 4–20 mA
- drive overheating
- ramp not followed
- external fault
- overspeed

For a Total reset (rSt = RSG), all faults except SCF (Motor Short Circuit) are overridden as long as the logic input assigned to Fault Reset is closed.

### CAUTION

#### MOTOR OVERHEATING

- Repeated reset of the thermal state after a thermal overload can result in thermal stress to the motor.
- When faults occur, promptly inspect the motor and driven equipment for problems (locked shaft, mechanical overload, etc.) before restarting. Also check the power supplied to the motor for abnormal conditions (phase loss, phase imbalance, etc.).

**Failure to follow these instructions can result in equipment damage.**



#### External Fault

Assigning a logic input to External Fault allows an external contact closure to stop the drive controller and motor. The stop type is determined by the configuration of the Stt parameter (Type of Stop) in the 3—Drive menu.

#### Force to Local

Permits going from serial link command to local command using the keypad display or terminal strip, depending on the setting of the LCC parameter in the 4—Control menu. Assigning this parameter selects a local command when the logic input is closed (state 1).

#### Auto-tuning

When the assigned logic input changes to 1 an auto-tuning operation is triggered, as parameter TUN is described on page 45 in the 3—Drive menu.

Auto tuning is only performed if no command has been activated. If a Freewheel Stop or Fast Stop function is assigned to a logic input, this input must be set to 1 (active at 0).

### Encoder Inputs

(Only with an I/O extension card with encoder input, VW3A58202U)

#### Speed Regulation

The inputs can be used to connect an encoder for improving speed regulation in applications where the load is changing. To program the encoder speed feedback, configure AI3 in the 5—I/O menu for RGI, Encoder Feedback. Then configure the encoder type and number of pulses in the 3—Drive menu.

The A, A-, B, and B- inputs on the I/O option card are for use in forward and reverse directions.

The A input can also be used with an inductive sensor or a photoelectric detector for simplified, but less accurate regulation.

#### Summing Speed Reference

The setpoint from the encoder input is summed with AI1.

## Using the Analog Inputs

The AI1 input is set for speed reference unless the PI Regulator function is enabled. In this case, AI1 is used for the set point reference. The possible assignments of AI2 and AI3 are Speed Reference Summing and PI Regulator.

### Speed Reference Summing

The frequency references at AI2 and AI3 can be summed with that at AI1.

### PI Regulator

This function is used to regulate a process with a setpoint input and a feedback signal from the process. The function is enabled by assigning an analog input (AI) to PI feedback in the 5—I/O menu after first ensuring that the Auto/Manual (RFC) parameter is not assigned to a logic input. This function is only available in the Variable Torque Macro. The acceleration (ACC) and deceleration (dEC) ramps default to linear ramp type even if the ramps had been configured for S ramp or U ramp with the *rPt* parameter.

When the PI regulator is configured and a logic input is configured for PAU: PI Auto/manual, the PI regulator function is active in Auto mode and AI3 is used for speed input in manual mode. To use the PI Auto/Manual function, you must install an analog option card, VW3A58201U.

Logic inputs can be used with the PI regulator to command the drive controller to run from the analog reference, run at process maximum, or operate with two other definable pre-set setpoints. The configurable setpoints can be used to provide two different setpoints for two different processes, or they can be used instead of using AI1 for setpoint input. For example, providing a setpoint via the logic inputs can eliminate the need for a potentiometer.

Four analog outputs are available to monitor various aspects of the PI regulator function. See pages 83–84 for more information.

PI setpoint	OPS	PI feedback	OPF
PI error	OPE	PI integral error	OPI

Figure 18 shows a diagram of the PI Regulator inputs, calculation points, and outputs.

Table 20 provides a description of the inputs to the PI Regulator.

**Figure 18: Diagram of PI Regulator**

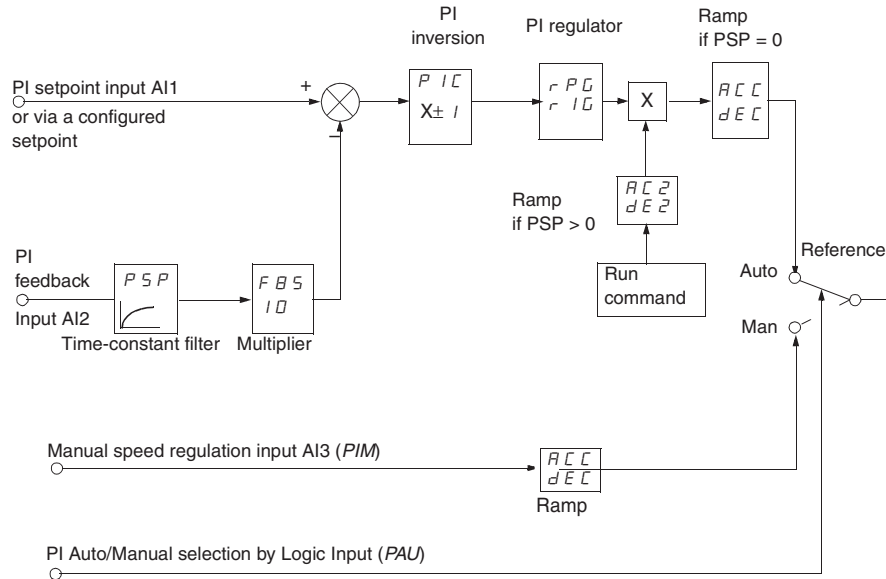

**Table 20: Definition of PI Regulator Inputs and Adjustments**

Input	Code	Range	Description
PI setpoint	—		The setpoint to the PI regulator can be provided from one of three sources: <ul style="list-style-type: none"> <li>via analog input, AI1 (AI2 and AI3 can be set to sum with AI1)</li> <li>via preset setpoints defined by logic inputs (see Preset setpoints in this table)</li> <li>over a communication network</li> </ul>
PI feedback	—		The feedback to the PI regulator can be provided from AI2 (0–20 mA signal) or AI3 (0–10 Vdc voltage signal).
Auto / Manual with manual speed Input	PAU, PIM		When the PI regulator is configured and a logic input is configured for PAU: PI Auto / Manual, AI3 is the speed input in manual mode. The PI regulator function is active in Auto mode. When the logic input is open, (set to state 0), Manual mode is active and the PI regulator is inactive. In manual mode AI3 is enabled and the drive controller responds proportionally to the speed reference at AI3. PI Regulator mode is active when the logic input is closed, (set to state 1).

**Table 20: Definition of PI Regulator Inputs and Adjustments** (continued)

Input	Code	Range	Description																												
Preset setpoints	<i>Pr2, Pr4</i>	0–100% of process maximum (HSP)	Logic inputs can also be used to provide programmable setpoints. Two or four preset setpoints require the use of one or two logic inputs respectively.																												
	<i>PI2, PI3</i>		<table border="1"> <thead> <tr> <th colspan="2">2 preset setpoints</th> <th colspan="3">4 preset setpoints</th> </tr> <tr> <th>Llx</th> <th>Reference</th> <th>Lly</th> <th>Llx</th> <th>Reference</th> </tr> </thead> <tbody> <tr> <td>0</td> <td>Analog reference</td> <td>0</td> <td>0</td> <td>Analog reference</td> </tr> <tr> <td>1</td> <td>Process max. (HSP)</td> <td>0</td> <td>1</td> <td>PI2 (adjustable)</td> </tr> <tr> <td></td> <td></td> <td>1</td> <td>0</td> <td>PI3 (adjustable)</td> </tr> <tr> <td></td> <td></td> <td>1</td> <td>1</td> <td>Process max. (HSP)</td> </tr> </tbody> </table> <p>For example, the factory settings of PI2 and PI3 are 30% and 60% respectively and if HSP is 60 Hz, PI2 setpoint will be 18 Hz and PI3 setpoint will be 36 Hz.</p>	2 preset setpoints		4 preset setpoints			Llx	Reference	Lly	Llx	Reference	0	Analog reference	0	0	Analog reference	1	Process max. (HSP)	0	1	PI2 (adjustable)			1	0	PI3 (adjustable)			1
2 preset setpoints		4 preset setpoints																													
Llx	Reference	Lly	Llx	Reference																											
0	Analog reference	0	0	Analog reference																											
1	Process max. (HSP)	0	1	PI2 (adjustable)																											
		1	0	PI3 (adjustable)																											
		1	1	Process max. (HSP)																											
PI Inversion	<i>PIC</i>	Yes/No	PI inversion permits an inverted, or reverse-acting, response to the PI setpoint signal. If PIC = No, the motor speed increases when the error is positive. If PIC = Yes, the motor speed decreases when the error is positive.																												
PI proportional gain	<i>rPG</i>	0.01–100	PI regulator proportional gain adjusts the scaling of the PI setpoint signal.																												
PI integral gain	<i>rIG</i>	0.01–100 s	PI regulator integral gain adjustment.																												
Time-constant feedback filter	<i>PSP</i>	0–10 s	PSP can be used to dampen the feedback signal. If PSP is set to zero, the ACC and dEC ramps are active. If PSP is > 0, the AC2/dE2 ramps are active. Adjustment of AC2/dE2 can be used to refine the response of the PI loop. The dEC ramp is always used on stopping.																												
PI feedback scaling	<i>FbS</i>	1.0–100	PI feedback scaling allows adjustment of the maximum value of the PI feedback signal so that it corresponds to the maximum value of the PI regulator speed reference.																												

**Assignment of AI2 and AI3**

**Summing Speed Reference:** The frequency setpoints given by AI2 and AI3 can be summed with AI1.

**Speed Regulation with Tachogenerator:** (Assignment on AI3 only with an I/O extension card, VW3A58201U)

An external divider bridge is required to adapt the voltage of the tachogenerator. The maximum voltage must be between 5 and 9 V. A precise setting is then obtained by setting the dtS parameter available in the 2—Adjust menu.

**PTC Probe Processing:** (only with an I/O extension card using the analog input). Used for direct thermal protection of the motor by connecting the PTC probes in the motor windings to analog input AI3.

Total resistance of the probe circuit at 20 °C = 750 Ω.

**Analog Torque Limit:** (Assignment on AI3 only with an I/O extension card VW3A58201U). This function can only be accessed if an analog input has been assigned to the torque limit. If the logic input is at 0, the torque is limited by the setting of TLI or tL2. If the logic input is at 1, the torque is limited by the analog input assigned to this function.

The signal applied at AI3 operates in a linear fashion on the internal torque limit (parameter TLI in the 3—Drive menu):

- If AI3 = 0 V: limit = TLI x 0 = 0
- If AI3 = 10 V: limit = TLI

### Using the Controller Relay and Logic Outputs

The relay R2 on the drive controller or the logic output (LO) on an option card can be configured as follows:

#### Drive Running (RUN)

The logic output is at state 1 if the drive controller is supplying current to the motor or if a run command is generated with a zero speed reference.

#### Output Contactor Command (OCC)

The Output Contactor Command function allows the drive controller to command a contactor between the controller and the motor. The controller closes the contactor when a run command is given. When there is no longer any current in the motor, the controller opens the contactor. When using an output contactor, set outphase loss (OPL) to No.

*NOTE: If the braking by DC injection function is configured, do not exceed contactor rating, because the contactor will not open until the end of braking.*

#### Frequency Threshold Attained (FtA)

The logic output is at state 1 if the motor frequency is greater than or equal to the frequency threshold set by the Ftd parameter in the 2—Adjust menu.

#### High Speed Attained (FLA)

The logic output is at state 1 if the motor frequency is equal to the high speed value (HSP).

#### Current Threshold Attained (CtA)

The logic output is at state 1 if the motor current meets or exceeds the current threshold set by the Ctd parameter in the 2—Adjust menu.

#### Frequency Reference Attained (SrA)

The logic output is at state 1 if the motor frequency is equal to the speed reference value.

#### Motor Thermal State Attained (tSA)

The logic output is at state 1 if the motor thermal state meets or exceeds the thermal threshold set by the ttd parameter in the 2—Adjust menu.

#### Brake Logic Command (bLC) (This parameter is only assignable to R2)

Brake Logic Command allows management of a mechanical brake by the drive controller. Figure 19 shows a timing diagram for Brake Logic.

Figure 19: Brake Logic Timing Diagram

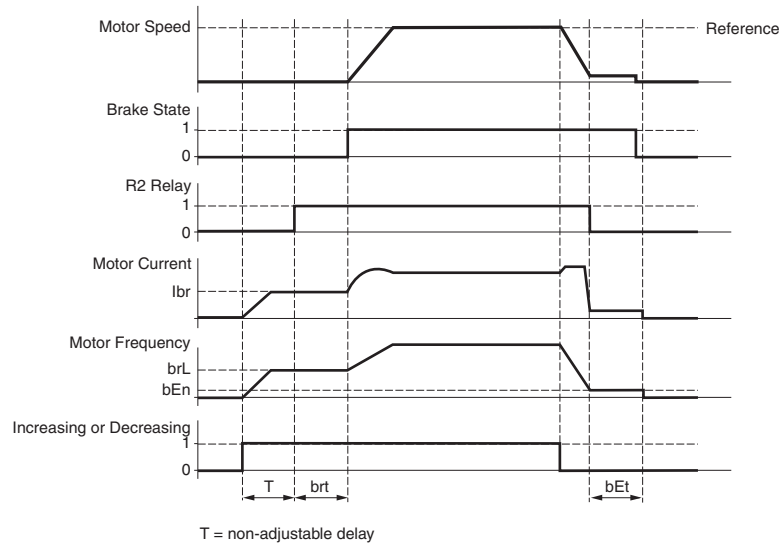

Parameters accessible in the 2—Adjust menu when bLC is assigned to R2:

- brake release frequency (brL)
- brake release current (lbr)
- brake release time (brt)
- brake engage frequency (bEn)
- brake engage time (bEt)

Recommendations for configuring the Brake Logic control parameters:

- Brake release frequency (brL):  
Set the brake release frequency to the value of the nominal motor slip (g) multiplied by the nominal frequency (FS) in Hz.

$$\text{brL} = \text{g} \times \text{FS}$$

g = nominal motor slip

FS = nominal motor frequency (indicated on the motor nameplate)

Example Calculation:

$$\text{nominal slip (g)} = (\text{Ns} - \text{Nr}) / \text{Ns}$$

Ns = synchronous speed in rpm

Nr = nominal motor speed at nominal torque in rpm. Use the speed indicated on the motor nameplate.

For a 50 Hz supply: Ns = 3000 rpm for a motor with two poles, 1500 rpm for a motor with four poles, 1000 rpm for a motor with six poles, and 750 rpm for a motor with eight poles.

For a 60 Hz supply: Ns = 3600 rpm for a motor with two poles, 1800 rpm for a motor with four poles, 1200 rpm for a motor with six poles, and 900 rpm for a motor with eight poles.

Example calculation: for a motor with four poles, a nameplate nominal speed of 1430 rpm, and a 50 Hz supply

$$\text{g} = (1500 - 1430) / 1500 = 0.0466$$

$$\text{Brake release frequency (brL)} = 0.0466 \times 50 = 2.4 \text{ Hz}$$

- Brake release current (lbr):  
Adjust the brake release current to the motor nameplate nominal current.

*NOTE: The values indicated (release current and release frequency) correspond to theoretical values. If during testing, the torque is insufficient using these theoretical values, retain the brake release current at the nominal motor current and lower the brake release frequency (up to 2/3 of the nominal slip). If the result is still not satisfactory, return to the theoretical values and then increase the brake release current (the maximum value is imposed by the drive controller) and increase the brake release frequency gradually.*



- Acceleration/deceleration time:  
It is advisable to set the acceleration and deceleration ramps to more than 0.5 seconds. Ensure that the drive controller does not exceed the current limit. A braking resistor should be used on overhauling loads.
- Brake release time (brt):  
Adjust according to the time required for the mechanical brake to open.
- Brake engage frequency (bEN):  
Set to twice the nominal slip (in the example above  $2 \times 0.0466 = 0.0932$  Hz). Then adjust according to observed results.
- Brake engage time (bEt):  
Adjust according to the time required for the mechanical brake to close.

#### Loss of 4–20 mA Signal (APL)

The logic output is at state 1 if the signal on the 4–20 mA speed reference input is less than 2 mA.

#### Frequency Threshold 2 Attained (F2A)

The logic output is at state 1 if the motor frequency is greater than or equal to the frequency threshold set by the F2d parameter in the 2—Adjust menu.

#### Drive Thermal Threshold Attained (tAd)

The logic output is at state 1 if the drive thermal state meets or exceeds the thermal threshold set by the dtd parameter in the 2—Adjust menu.

### Using the Analog Outputs

The analog outputs on the drive controller and on the Analog I/O and Digital I/O extension cards are current outputs. The minimum and

maximum values (AOL and AOH parameters) are configurable, each with a range of 0–20 mA.

**Figure 20: Analog Output Minimums and Maximums**

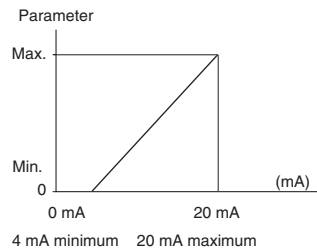

#### Motor Current

When configured for motor current (OCr), the analog output provides a signal proportional to motor current. The minimum configured value corresponds to zero while the maximum configured value of the analog output corresponds to 200% of the drive controller's constant torque rating.

#### Output Frequency

When configured for output frequency (OFr), the analog output provides a signal proportional to the motor frequency estimated by the drive controller. The minimum configured value corresponds to zero while the maximum configured value of the analog output corresponds to the maximum frequency setting, not the high speed setting.

#### Ramp Output

When configured for ramp output (OrP), the analog output provides a signal proportional to the frequency the drive controller is commanding the motor to run. The minimum configured value (AOL) corresponds to zero while the maximum configured value of the analog output (AOH) corresponds to the maximum frequency setting (tFr), not the high speed setting.

#### Motor Torque

When configured for motor torque (trq), the analog output provides a signal proportional to motor torque as an absolute value. The minimum configured value (AOL) corresponds to zero while the

maximum configured value of the analog output (AOH) corresponds to 200% of the nominal motor torque.

#### Signed Motor Torque

When configured for signed motor torque (Stq), the analog output provides a signal proportional to motor or braking torque. Zero torque corresponds to:

$$(AOL + AOH)/2$$

The minimum configured value (AOL) corresponds to 200% braking torque while the maximum configured value of the analog output (AOH) corresponds to 200% of the nominal torque.

#### Signed Ramp

When configured for signed ramp output, ORS, the analog output provides a signal proportional to the frequency the drive controller is commanding the motor to run in the reverse or forward direction. Zero frequency corresponds to:

$$(AOL+AOH) / 2$$

The minimum configured value, AOL, corresponds to the maximum frequency (tFr) in the reverse direction, while the maximum configured value, AOH, corresponds to the maximum frequency (tFr) in the forward direction.

#### PI Setpoint

When configured for PI setpoint, OPS, the analog output provides a signal proportional to the PI setpoint being provided to the drive controller. The minimum configured value, AOL, corresponds to the minimum setpoint, while the maximum configured value, AOH, corresponds to the maximum setpoint.

#### PI Feedback

When configured for PI feedback, OPF, the analog output provides a signal proportional to the PI feedback being provided to the drive controller. The minimum configured value, AOL, corresponds to the minimum feedback, while the maximum configured value, AOH, corresponds to the maximum feedback.

#### PI Error

When configured for PI error, OPE, the analog output provides a signal proportional to the PI regulator error as a percentage of the sensor range being used for the PI feedback, (maximum feedback minus minimum feedback). The minimum configured value, AOL, corresponds to – 5%, while the maximum configured value, AOH, corresponds to +5%. Zero corresponds to (minimum value + maximum value) / 2, (AOL+AOH) / 2.

#### PI Integral Error

When configured for PI integral error, OPI, the analog output provides a signal proportional to the PI integral error. The minimum configured value, AOL, corresponds to the low speed setting, LSP, while the maximum configured value, AOH, corresponds to the high-speed setting, HSP.

#### Motor Power

When configured for motor power, OPR, the analog output provides a signal proportional to power drawn by the motor. The minimum configured value, AOL, corresponds to 0% of the nominal motor power, while the maximum configured value, AOH, corresponds to 200% of the nominal motor power.

#### Motor Thermal State

When configured for motor thermal state, THR, the analog output provides a signal proportional to the thermal state of the motor calculated by the drive controller. The minimum configured value, AOL, corresponds to 0% of the motor thermal state, while the maximum configured value, AOH, corresponds to 200% of the motor thermal state.

#### Drive Thermal State

When configured for drive thermal state, THD, the analog output provides a signal proportional to the thermal state of the drive controller. The minimum configured value, AOL, corresponds to 0% of the drive controller thermal state, while the maximum configured value, AOH, corresponds to 200% of the drive controller thermal state.

## 6—Fault Menu

This menu is only accessible when the access locking switch is in the  position. Modifications can only be made when the motor is stopped.

**Table 21: 6—Fault Menu**

# Menu 6

Parameter	Code	Description	Adjustment Range	Factory Setting
Auto Restart	<i>R E r</i>	<p>This function allows an automatic restart of the drive controller if the cause of the fault has disappeared and a run command is maintained.</p> <p>An automatic restart is possible after the following faults:</p> <ul style="list-style-type: none"> <li>• OSF Input line overvoltage</li> <li>• ObF overbraking</li> <li>• OtF motor overheating (when the thermal sensor resistance is less than 1500 ohms)</li> <li>• LFF loss of 4–20 mA</li> <li>• OLF motor overload (after the thermal state has decreased below 100%)</li> <li>• OPF motor phase loss</li> <li>• OHF drive overheating (when the thermal state has decreased below 70%)</li> <li>• SLF loss of RS-485 port communication</li> <li>• EPF external fault</li> <li>• CnF network communication fault</li> </ul> <p>When the Auto restart is active, the fault relay remains energized. If the fault has disappeared, the drive controller will attempt to restart the motor after a delay time set by parameter tAr. If the drive controller remains faulted after attempting the number of restarts set in the parameter nAr, the fault relay de-energizes and the drive controller must be reset by cycling power.</p>	Yes - No	No

### WARNING

#### AUTOMATIC RESTART

- Automatic restart can only be used for machines or installations that present no danger in the event of automatic restarting, either for personnel or equipment.
- Equipment operation must conform with national and local safety regulations.

**Failure to follow this instruction can result in death, serious injury, or equipment damage.**

★ This parameter is only available on 125–500 hp drive controllers.

# Menu 6

**Table 21: 6—Fault Menu**

Parameter	Code	Description	Adjustment Range	Factory Setting
Nb max reset	n R r	This parameter is used to set the number of restart attempts.	0-255	5
Reset Pause	t R r	This parameter sets the delay time between Auto restart attempts.	0.1 to 999.9 s	30.0 s
Reset Type	r S t	<p>Faults reset by a partial reset (rSt = RSP) are:</p> <ul style="list-style-type: none"> <li>• OSF Input line overvoltage</li> <li>• ObF overbraking</li> <li>• OtF motor overheating</li> <li>• LFF loss of 4–20 mA</li> <li>• OLF motor overload</li> <li>• RnF ramp not followed</li> <li>• SOF overspeed</li> <li>• OPF motor phase loss</li> <li>• OHF drive overheating</li> <li>• SLF loss of RS-485 port communication</li> <li>• EPF external fault</li> <li>• CnF network communication fault</li> </ul> <p>All faults except motor short circuit are reset by a total reset (rSt = RSG).</p> <p>Total reset overrides all other faults. To configure rSt to RSG:</p> <ol style="list-style-type: none"> <li>1. Display RSG</li> <li>2. Press the ENT key.</li> <li>3. The drive controller displays “See manual”.</li> <li>4. Press the up arrow key, then the down arrow key, then ENT twice.</li> </ol>	<p>RSP (partial reset) RSG (total reset)</p>	RSP

*NOTE: Reset Type is accessible if the Reset Fault function is assigned to a logic input.*

## CAUTION

### MOTOR OVERHEATING

- Repeated reset of the thermal state after a thermal overload can result in thermal stress to the motor.
- When faults occur, promptly inspect the motor and driven equipment for problems such as locked shaft and mechanical overload before restarting. Also check the power supplied to the motor for abnormal conditions such as phase loss and phase imbalance.

**Failure to follow these instructions can result in equipment damage.**

★ This parameter is only available on 125–500 hp drive controllers.

# Menu 6

**Table 21: 6—Fault Menu**

Parameter	Code	Description	Adjustment Range	Factory Setting
OutPhaseLoss	OPL	Use to enable the output phase loss protection.  <b>Set this parameter set to No if there is a contactor between the drive controller and the motor, or if multiple motors are used on the output of the drive controller.</b>  It may also be necessary to set OPL to No if the motor load is less than 25% of the drive controller current rating (I <sub>n</sub> ).	Yes - No	Yes
Input Phase Loss	IPL	Allows activation of the Input Phase Loss fault.  This fault is not configurable on the following single phase input drive controllers: <ul style="list-style-type: none"> <li>• ATV58•U09M2</li> <li>• ATV58•U18M2</li> </ul> Disable IPL when operating the 208/230 Vac drive controllers with single phase input.	Yes - No	Yes
ThermalProType	THL	This function defines the type of thermal protection.  Choices: <ul style="list-style-type: none"> <li>• No: No motor thermal protection.</li> <li>• ACL: Self-cooled motor. The drive controller takes into account a derating as a function of the rotation frequency.</li> <li>• FCL: Force-cooled motor. The drive controller does not take into account a derating as a function of the rotation frequency.</li> </ul>	No - ACL - FCL	ACL

★ This parameter is only available on 125–500 hp drive controllers.

# Menu 6

**Table 21: 6—Fault Menu**

Parameter	Code	Description	Adjustment Range	Factory Setting
LossFollower	L F L	<p>Allows activation of a loss of 4–20 mA follower fault. This fault can only be configured if the minimum and maximum reference parameters for AI2 (CrL and CrH) are greater than 3 mA. If CrL &gt; CrH, LFL is automatically set to Yes.</p> <ul style="list-style-type: none"> <li>No: Disabled</li> <li>Yes: Immediate fault</li> <li>STT: Stop without fault, restart on return of signal</li> <li>LSF: Stop followed by fault signal from R1 and LFF display on the keypad</li> <li>LFF: Run at the preset speed set by the LFF parameter</li> <li>RLS: Run at last speed on loss of follower without fault. Follow analog input upon return of analog signal.</li> </ul> <p><i>NOTE: With Loss of Follower configured and Auto-Manual configured, the drive controller will fault when in Manual mode if the Auto signal is not present. Also, with Loss of Follower configured and Keypad command configured, the drive controller will fault when in Keypad mode if the Auto signal is not present.</i></p>	No	No
4-20 Flt Spd	L F F	Pre-set speed in the event of the loss of the 4–20 mA signal.	0–HSP	0
Catch On Fly	F L r	<p>Allows a smooth restart after:</p> <ul style="list-style-type: none"> <li>Brief loss of input power</li> <li>Fault reset or automatic restart</li> <li>Freewheel stop or DC injection braking with a logic input</li> <li>Momentary interruption of the drive controller output</li> </ul> <p>If relay R2 is assigned to the Brake Logic function, FLr will always be set to No.</p>	Yes - No	No

## WARNING

### AUTOMATIC RESTART

- Automatic catch on the fly must only be used on machines or installations where automatic restarting will not endanger personnel or equipment.
- Equipment operation must conform with national and local safety regulations.

**Failure to follow this instruction can result in death, serious injury, or equipment damage.**

★ This parameter is only available on 125–500 hp drive controllers.



# Menu 6

**Table 21: 6—Fault Menu**

Parameter	Code	Description	Adjustment Range	Factory Setting
Cont. Stop	<i>S E P</i>	Controlled stop upon loss of input phase.  This function is only operational if the IPL parameter (Input Phase Loss) is set to No. If IPL is set to Yes, leave StP set to No. Possible choices: <ul style="list-style-type: none"> <li>No: loss of input phase causes drive controller to trip</li> <li>MMS: Maintenance of DC bus: the DC bus is kept energized by regenerating the kinetic energy from the machine inertia, until the USF (Undervoltage) fault appears.</li> <li>FRP: Following a ramp: deceleration following the programmed ramp, either dEC or dE2 until the motor stops or the USF (Undervoltage) fault appears. This operation is not available on the ATV58•U09M2, U18M2, U29M2 and U41M2.</li> </ul>	No - MMS - FRP	No
RampNotFoll	<i>S d d</i>	This function can be accessed if feedback via tachogenerator or pulse generator is programmed.  When enabled, it is used to lock the drive controller if a speed error is detected (difference between the stator frequency and the measured speed).	Yes - No	No
External fault ★	<i>E P L</i>	This configuration is used to determine the response to an external fault. <ul style="list-style-type: none"> <li>Yes: immediate fault</li> <li>Stt: stop according to Stt setting</li> </ul>	Yes - Stt	Yes

★ This parameter is only available on 125–500 hp drive controllers.

## 7—Files Menu

The Files menu is accessible when the access locking switch is set to the total unlocked, , position. Changes can only be made when the motor is stopped.

The keypad display can store four drive controller configuration files.

A stored file can be downloaded into other drive controllers that have the same horsepower and voltage rating and the same or earlier version of firmware.

# Menu 7

*NOTE: The stored program will be substituted for present settings when a file is transferred to the drive controller.*

*NOTE: Factory default settings will be substituted for present settings when Ini is selected and confirmed by pressing ENT twice when prompted. Parameters LCC and Add remain at their previous settings.*

**Table 22: 7—File Menu**

Parameter	Code	Description	Factory Setting
File 1 State	F 1 5	Displays the state of the corresponding file. Possible states: • FRE: File free • EnG: A configuration has already been saved in this file	FRE
File 2 State	F 2 5		FRE
File 3 State	F 3 5		FRE
File 4 State	F 4 5		FRE
Operat. Type	F 0 E	Selects a file operation. Possible operations: • NO: no operation requested (default setting each time the keypad display is reconnected to the drive controller). • STR: save the configuration in a keypad display file. • REC: transfer a file to the drive controller. • Ini: return the drive controller to the factory settings.	NO

## WARNING

### UNINTENDED EQUIPMENT ACTION

- Verify that the factory default or transferred file settings are compatible with the application requirements.
- If a stored file is downloaded with the stop key disabled, this file will be transferred. To stop the motor, an external stop command must be installed.

**Failure to follow these instructions can result in death, serious injury or equipment damage.**

Password	□ □ □	See "Access Code" on page 92.	
----------	-------	-------------------------------	--

### Reinitializing the Drive Controller

Figure 21 shows the process of storing and recalling files to reinitialize the drive controller. Follow the path indicated by the bold lines.

**Figure 21: Reinitializing the Drive Controller**

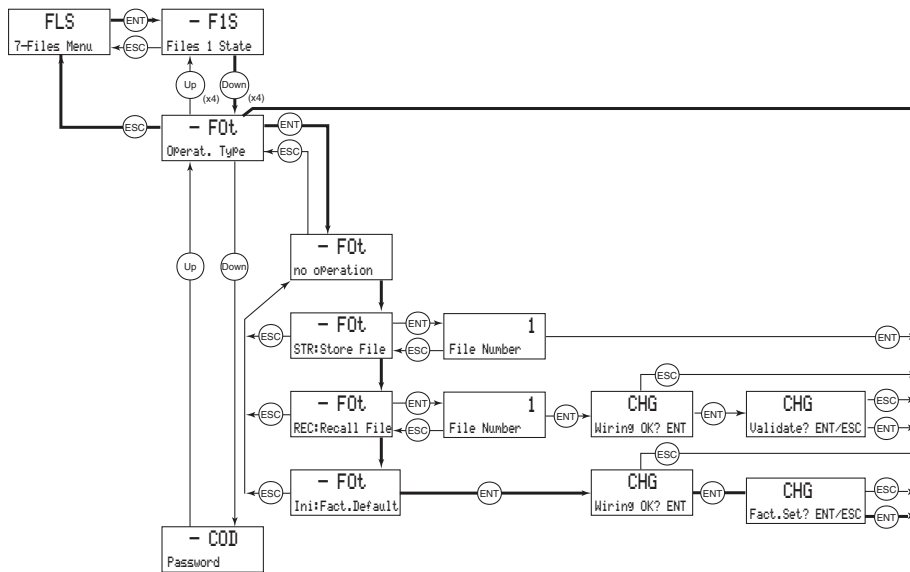

### File Operation

To store or recall a file:

- Set Operation Type (F0t) to STR to store a file, or REC to recall a file.
- Select the FILE number to specify the file.

- If storing a file, the display automatically returns to the FOt (Operation Type) parameter after storing the file.
- If the FOt parameter is set to REC, a second confirmation must be made:

The display indicates:

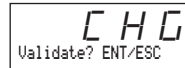

Press ENT to confirm.

The display then indicates:

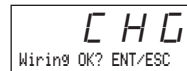

Press ENT to confirm.

The display automatically returns to the FOt parameter, set to No.

### Access Code

The drive controller configuration can be protected by an access code (password).

**Table 23: Access Code**

Parameter	Code	Description	Factory setting
Config. Code	[ ] d	Configuration code used as an access code.	0000

*NOTE: Use this parameter with caution. It can prohibit access to parameters. Carefully note and save any modification to this parameter.*

The access code is expressed with four digits. The first three are user-assigned and do not affect access to the menus. The fourth digit can range from 0 to 9 and determines which menus can be accessed. See Table 24 for an explanation of the last digit codes.

**Figure 22: Access Code**



↑  
this number gives the authorized level of access

For example, if the access code is “2337”, display of the menus 2, 3, 4, 5, 6, 7, and 8 is allowed, but modification is not allowed.

**Table 24: Significance of Access Code Last Digit**

Menus Affected:	Access is locked if last digit of code is:	Display is allowed if last digit of code is:	Modification is allowed if last digit of code is:
2	0 <sup>[1]</sup> or 9	1	2
2, 3, 4, 5, 6, 7, 8, and Macro-Configuration	0 <sup>[1]</sup> or 9	3	4
8	0 <sup>[1]</sup> or 9	5	6
2, 3, 4, 5, 6, 7, 8	0 <sup>[1]</sup> or 9	7	8

<sup>[1]</sup> If the factory setting, 0000, is used, access to the menus is completely unlimited.

*NOTE: Menu access allowed by the locking switch setting can be limited by the access code.*

The access code is set by using the ▲ and ▼ keys. Press ENT twice to validate the code you have chosen. The display reverts to 0 indicating the password has been accepted. The menus are now locked and your access code must be entered to unlock them. If an incorrect code is entered, it is refused, and the following message is displayed:

**Figure 23: Incorrect Code Display**



After pressing ENT or ESC on the keypad display, the user can try to reenter the correct code.

To access the menus protected by the access code, the correct code must first be entered in the File menu. The File menu is always accessible. Once the correct code has been entered, press ENT and then press ESC twice to get to the menu tree. Display and modifications are now allowed per the code entered.

After completing your changes, cycle power or remove the keypad to re-lock access to the menus.

Menu 8 will only appear on the keypad display if a communication option card or application option card has been installed in the drive controller. Communication option cards contains drivers and connection points for integration into various industrial and building automation networks. Application option cards expand the I/O

functionality of the drive controller. See Appendix B for a list of option cards available from Schneider Electric/Square D Company.

## 8—Communication Menu

### Menu 8

The Communication menu is displayed only if a communication card is installed. It is accessible when the access locking switch is set to the total unlock  position. Configuration can only be done while the motor is stopped.

For information on the communication option cards, refer to the manuals supplied with the cards.

## 8—Application Menu

### Menu 8

The Application menu is only displayed if a custom application card is installed. It is accessible when the access locking switch is set to the total unlock  position. Configuration can only be done while the motor is stopped.

For more information concerning the custom application card, see the document provided with the card.

Several custom application option cards are available for specific OEM accounts. See Appendix B for a list of option cards available from Schneider Electric.

The General Purpose Option Card (catalog no. VW3A58253U) is considered a custom application card. For information on programming the card see instruction bulletin 30072-450-03.

## CHAPTER 3—DIAGNOSTICS AND TROUBLESHOOTING

### Keypad Display and Indicating LEDs

When a fault condition is detected, a fault code and a plain language message will be displayed as long as power is maintained. See Table 27 on page 103 for fault codes and messages. In addition, the LEDs on the front of the drive controller indicate the states illustrated in Figure 24.

**Figure 24: Location and Description of LEDs**

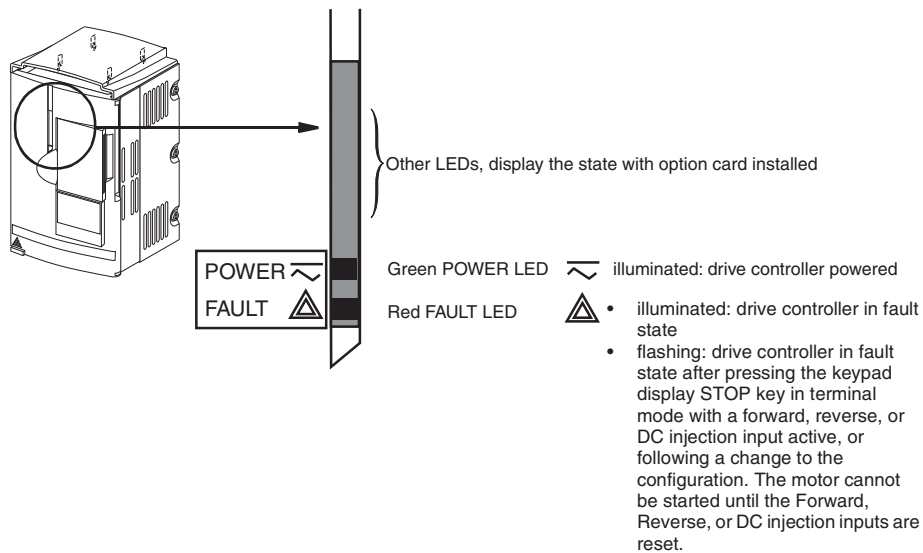

### Fault Storage

The first fault detected is saved and displayed on the keypad display if power is maintained. The drive controller trips, the red fault LED illuminates, and the fault relay de-energizes. To reset the fault:

1. Remove power from the drive controller.
2. Before restoring power, identify and correct the cause of the fault.
3. Restore power. This will reset the fault if it has been corrected.

In certain cases, if automatic restart has been enabled, the drive controller can be automatically restarted after the cause of the fault has been corrected. See page 85.

### Using Fault Codes and Messages to Solve Problems

The fault messages displayed on the keypad display can be used to troubleshoot problems. The fault messages can be divided into three categories:

- **Protective faults:** These faults are displayed when the drive controller detects conditions that, if left uncorrected, may result in damage to the drive controller and/or motor. The drive controller shuts down to prevent further damage from occurring.
- **Drive faults:** These faults are displayed when a problem is detected in the drive controller.
- **Process faults:** These faults are displayed when a process feedback or communication signal used by the drive controller is interrupted.

**Table 25: Fault Messages**

Protective Faults	Drive Faults	Process Faults
Input phase loss	Precharge fault	Loss of 4–20 mA signal
Undervoltage	EEPROM fault	Loss of RS-485
Overvoltage	Internal fault	External fault
Drive overheating	Internal communication fault	Speed feedback fault
Motor overload	Power rating error	Communication network fault
Overbraking	Option error	
Motor phase loss	Option removed	
Overcurrent	EEPROM checks	
Motor short circuit		
Motor overheating		
Thermal sensor fault		
Overspeed		
Ramp not followed		

### Maintenance

Read the safety statements on page 97 before proceeding with any maintenance or troubleshooting procedures.



At regular intervals perform the following steps:

- Check the condition and tightness of the connections.
- Make sure that the ventilation is effective and the temperature around the drive controller remains within specified levels.
- Remove dust and debris from the drive controller, if necessary.

### Precautions

Table 27 on page 103 lists faults, associated codes, the probable causes of the faults, and the associated corrective action. When taking corrective action, follow the procedures outlined on pages 98–102.

 <b>DANGER</b>
<b>HAZARDOUS VOLTAGE</b>
Read and understand these procedures before servicing ATV58 <i>TRX</i> drive controllers. Installation, adjustment, and maintenance of these drive controllers must be performed by qualified personnel.
<b>Electrical shock will result in death or serious injury.</b>

The following procedures are intended for use by qualified electrical maintenance personnel and should not be viewed as sufficient instruction for those who are not otherwise qualified to operate, service, or maintain the equipment discussed.

## Procedure 1: Bus Voltage Measurement

**⚠ DANGER**

**HAZARDOUS VOLTAGE**

- Read and understand the bus voltage measurement procedure before performing the procedure. Measurement of bus capacitor voltage must be performed by qualified personnel.
- DO NOT short across DC bus capacitors or touch unshielded components or terminal strip screw connections with voltage present.
- Many parts in this drive controller, including printed wiring boards, operate at line voltage. DO NOT TOUCH. Use only electrically insulated tools.

**Electrical shock will result in death or serious injury.**

The DC bus voltage level is determined by monitoring the (+) and (–) measurement points. Their location varies by drive controller model number as listed in Table 26 and shown in Figure 25. The drive controller model number is listed on its nameplate.

**Table 26: ATV58 TRX Type H (+) and (–) Measurement Points**

Drive Controller ATV58H*****	(+ ) Measurement Point		(– ) Measurement Point	
	Terminal Block or Connector	Terminal Designation	Terminal Block or Connector	Terminal Designation
U09M2* and U18M2*	J2	(+)	J2	(–)
U29M2* to D12M2* U18N4* to D23N4*	J2	PA	J18	7
D16M2* to D46M2* D28N4* to D79N4*	J2	(+)	J2	(–)
C10N4* to C33N4*		PA (+)		PC (–)

To measure the DC bus capacitor voltage:

1. Disconnect all power from the drive controller including external control power that may be present on the control board and the option board terminals.
2. Wait ten minutes for the DC bus capacitors to discharge.

3. Read the model number of the drive controller from the nameplate and identify the corresponding (+) and (–) measurement points from Table 26 and Figure 25.
4. Open the door or cover of the drive controller.
5. Set the voltmeter to the 1000 Vdc scale. Measure the voltage between the (+) and (–) measurement points identified in step 3. Verify that the DC bus voltage has discharged below 45 V before servicing the drive controller.
6. If the DC bus capacitors will not discharge below 45 V, contact your local Square D representative. **Do not operate the drive controller.**
7. Replace all of the covers after servicing the drive controller.

**Figure 25: DC Bus Measurement Terminals**

The J18 connector is in the upper left hand corner of the main control board behind the flexible shield. Use a thin probe to access the connector pin.

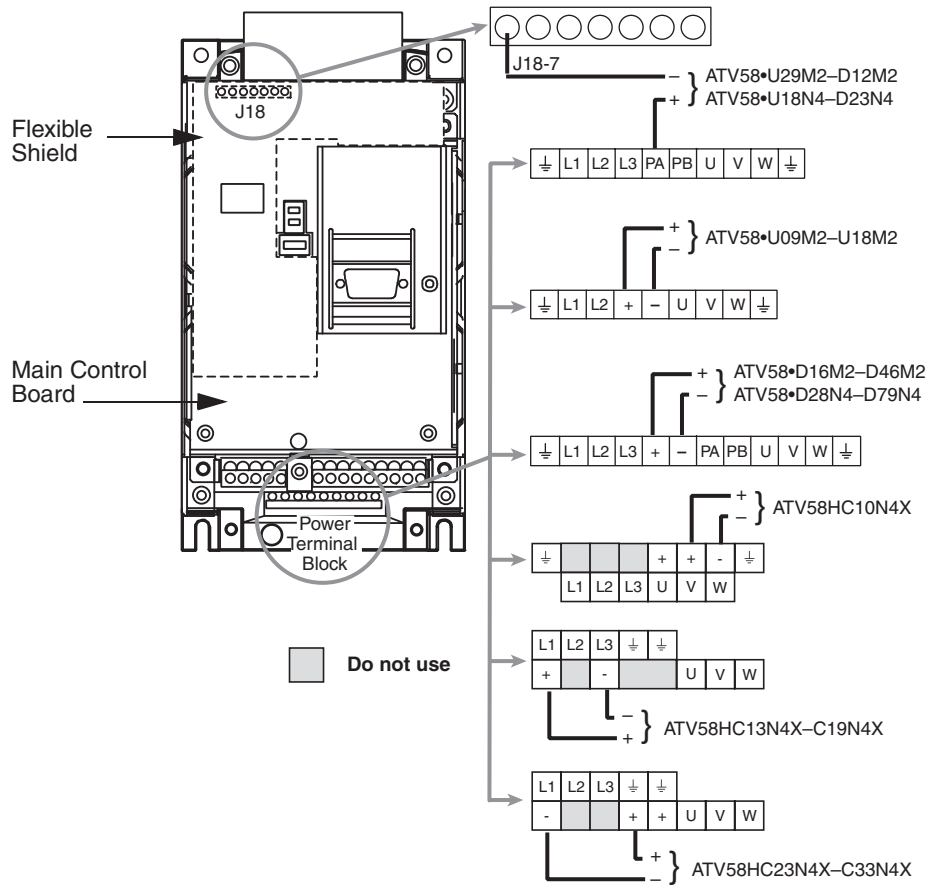

**Figure 26: Power Terminal Layout**

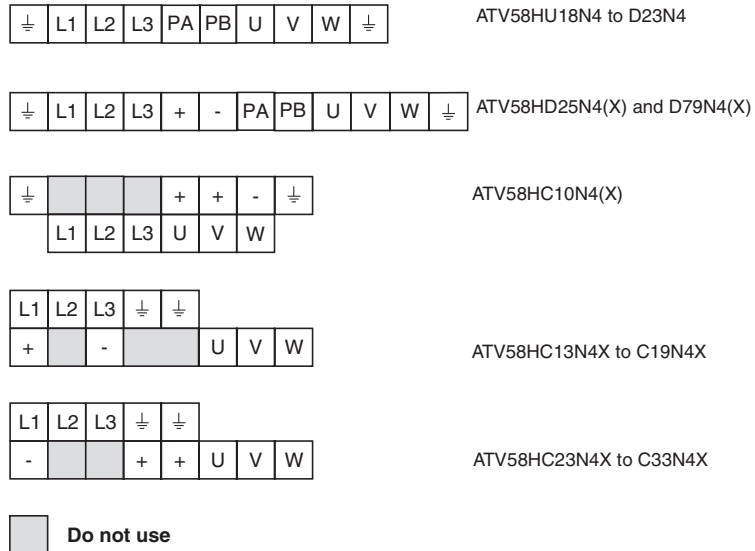

### Procedure 2: Checking Supply Voltage

Measure the input line voltage to determine if the voltage is within the drive controller tolerance.

1. Perform the Bus Voltage Measurement procedure on page 98.
2. Attach meter leads to L1 and L2. Set the voltmeter to the 600 Vac scale.
3. Reapply power and check for the correct line voltage, shown on the drive controller nameplate rating.
4. Remove power and repeat the procedure for L2 and L3, and L1 and L3.
5. When all phases have been measured, remove power. Remove leads and replace all covers.

### Procedure 3: Checking the Peripheral Equipment

The following equipment may need to be checked. Follow the manufacturers' procedures when checking this equipment.

1. A protective device, such as a circuit breaker, may have tripped or a fuse may have blown.
2. A switching device, such as a contactor, may not be closing at the correct time.
3. Conductors may require repair or replacement.
4. Connection cables to the motor or high resistance connections to ground may need to be checked. Follow NEMA standard procedure WC-53.
5. Motor insulation may need to be checked. Follow NEMA standard procedure MG-1. *Do not apply high voltage to U, V, or W.* Do not connect the high potential dielectric test equipment or insulation resistance tester to the drive controller since the test voltages used may damage the drive controller. Always disconnect the drive controller from the conductors or motor while performing such tests.

#### CAUTION

##### **DIELECTRIC TESTS WHILE CONNECTED Can Cause Equipment Damage**

- Do not perform high potential dielectric tests on circuits while the circuits are connected to the drive controller.
- Any circuit requiring high potential dielectric tests must be disconnected from the drive controller prior to performing the test.

**Failure to follow these instructions can result in injury or equipment damage.**

## Fault Codes and Messages

**Table 27: Fault Codes and Messages**

Fault/Message	Probable Causes	Corrective Actions
<i>C F F</i> PWR RATE ERR-ENT OPTION ERR.-ENT OPT. REMOVED-ENT EEP CKS.-ENT	<p>Error probably caused by changing a card.</p> <p>Change of the power rating on the power board</p> <p>Change of the type of option card or installation of an option card if one had not been installed before and the macro-configuration was CUS</p> <p>Option card removed</p> <p>Saved configuration cannot be read. Pressing ENT causes the message "Fact.Setting? ENT/ESC" to appear.</p>	<p>Check the configuration of the power board and other boards.</p> <p>Reset by cycling power.</p> <p>Save the configuration in a file on the keypad display.</p> <p>Press ENT to return to factory settings.</p>
<i>C F I</i> CONFIG FAULT	The configuration sent to the drive controller via the serial link cannot be read.	<ol style="list-style-type: none"> <li>1. Verify the configuration sent.</li> <li>2. Send a configuration which can be read.</li> </ol>
<i>C n F</i> COMM. NETWORK FAULT	Fault on the communication network.	<ol style="list-style-type: none"> <li>1. Check the connection of the communication network to the drive controller.</li> <li>2. Check the network time-out setting.</li> </ol>
<i>C r F</i> PRECHARGE FAULT	<ul style="list-style-type: none"> <li>• Precharge relay closure command fault.</li> <li>• Failed precharge resistor.</li> </ul>	<p>Perform Bus Voltage Measurement Procedure (Procedure 1 on page 98). Check connections in drive controller.</p>
<i>E E F</i> EEPROM FAULT	Memory error.	Remove power from the drive controller and reset.
<i>E P F</i> EXTERNAL FAULT	Fault caused by an external source such as a PLC or general purpose option (GPO) card. An EPF fault is generated whenever a GPO card is installed.	Verify the external source which caused the fault and reset. If the drive controller has a GPO card installed, see instruction bulletin 30072-450-03 for programming and troubleshooting instructions.
ERR 1	Internal error in the keypad display	Cycle power on the drive controller. If the problem persists, replace the keypad display with part number VW3A58101U.
ERR 2	Serial link error due to incorrect address	<ul style="list-style-type: none"> <li>• Verify address setting.</li> <li>• Cycle power on drive controller</li> </ul>

Table 27: Fault Codes and Messages (continued)

Fault/Message	Probable Causes	Corrective Actions
ERR 3	Serial link error due to incorrect value. If the keypad display is remotely mounted, electrical noise may be present.	Cycle power on the drive controller. If the keypad display is remotely mounted, verify that the cable is properly shielded. Ensure that the cable is routed away from motor leads. If the problem persists, replace the keypad display with part number VW3A58101U. Reprogram any parameters that are not at factory default settings.
ERR 4	Internal error in the keypad display software. If the keypad display is remotely mounted, electrical noise may be present.	Cycle power on the drive controller. If the problem persists, replace the keypad display with part number VW3A58101U.
ERR 5	Serial link error. If the keypad display is remotely mounted, electrical noise may be present.	Cycle power on the drive controller. If the keypad display is remotely mounted, verify that the cable is properly shielded. Ensure that the cable is routed away from motor leads. See page 58 for instructions for resetting the tbr parameter back to 19200 bits/s. If the problem persists, replace the control board on the drive controller with part number VX4A581U. An Ini fault may be displayed if the problem persists.
ERR 6	Internal error in the keypad display hardware	Cycle power on the drive controller. If the keypad display is remotely mounted, verify that the cable is properly shielded. Ensure that the cable is routed away from motor leads. Re-program any parameters that are not at factory default settings. If the problem persists, replace the keypad display with part number VW3A58101U.
ERR 7	Serial link time out error. The keypad display is not getting a response from the drive controller. If the keypad display is remotely mounted, electrical noise may be present. The port baud rate (tbr) may be set to 9600 bits/s.	Cycle power on the drive controller. If the keypad display is remotely mounted, verify that the cable is properly shielded. Ensure that the cable is routed away from motor leads. If the problem persists, replace the keypad display with part number VW3A58101U. Re-program any parameters that are not at factory default settings.
ERR 8 ERR 9	Internal error in the keypad display software. If the keypad display is remotely mounted, electrical noise may be present.	Perform the Bus Voltage Measurement procedure (Procedure 1 on page 98). Check the connection between the option card and the control board. If the drive controller has a GPO card installed, see instruction bulletin 30072-450-03 for troubleshooting instructions.
ERR10	Serial link error due to incorrect length of frame. If the keypad display is remotely mounted, electrical noise may be present.	Perform the Bus Voltage Measurement procedure (Procedure 1 on page 98), then check internal connections.
ILF INTERNAL COMM. FAULT	Communication fault between the control board and the option card.	
INF INTERNAL FAULT	<ul style="list-style-type: none"> <li>• Internal fault.</li> <li>• Internal connection fault.</li> </ul>	



Table 27: Fault Codes and Messages (continued)

Fault/Message	Probable Causes	Corrective Actions
<i>In</i>	Attempting to download an incompatible file from the keypad display to the drive controller. Incompatibility can be caused by transferring to a drive controller with dissimilar part numbers. Also, incompatibility can occur when files are created on a drive controller with new firmware and then attached to a controller with older firmware. The error may appear after ERR7 is displayed.	<ol style="list-style-type: none"> <li>1. Ensure that the file being downloaded was created for the correct drive controller part.</li> <li>2. Verify drive controller firmware. Reconfigure the new features used in the newer firmware. Like configurations are transferable independent of firmware revision. Another option is to upgrade the firmware by ordering part number VX4A581U. Cycle power on the drive controller.</li> </ol>
<i>L F F</i> LOSS OF 4–20 mA	Loss of 4–20 mA follower signal on AI2 input. See Table 29 on page 107.	<ol style="list-style-type: none"> <li>1. Verify signal connections.</li> <li>2. Check signal.</li> </ol>
<i>O b F</i> OVERBRAKING	Overvoltage or overcurrent due to excessive braking or an overhauling load. See Table 28 on page 106.	Increase deceleration time. Add a dynamic braking option if necessary, or verify that the dynamic braking option is working properly.
<i>O C F</i> OVERCURRENT	<ul style="list-style-type: none"> <li>• Ramp too short.</li> <li>• Inertia too high, or load too large</li> <li>• Mechanical blockage.</li> </ul>	<ol style="list-style-type: none"> <li>1. Check the parameter settings.</li> <li>2. Check the sizing of the drive controller, motor, and load.</li> <li>3. Remove all power. With the drive controller disconnected, check for mechanical blockage.</li> </ol>
<i>O H F</i> DRIVE OVERHEATING	Heatsink temperature too high.	Check the motor load, fan, and the ambient temperature around the drive controller. Wait for the drive controller to cool down before resetting.
<i>O L F</i> MOTOR OVERLOAD	<ul style="list-style-type: none"> <li>• If the thermal trip setting meets or exceeds 118% of the normal thermal state, thermal trip is due to prolonged overload or output phase failure.</li> <li>• Motor power rating is too low for the application.</li> </ul>	<ul style="list-style-type: none"> <li>• Check the setting of Thermal Current (<i>I L H</i>, see page 32) and compare it with motor <math>I_n</math> (nameplate current rating). Check the load and compare it with operating speed. Check the braking conditions (possibility of single-phase operation). Wait approximately seven minutes before resetting.</li> <li>• Verify that the motor and drive controller selections are correct for application.</li> </ul>
<i>O P F</i> MOTOR PHASE LOSS	<ul style="list-style-type: none"> <li>• Loss of a phase on the output of the drive controller.</li> <li>• Drive controller oversized for motor.</li> </ul>	<ol style="list-style-type: none"> <li>1. Check the wiring to the motor (Procedure 3 on page 102).</li> <li>2. Disable OPL and provide external overload protection.</li> </ol>
<i>O S F</i> OVERVOLTAGE	Supply too high. See Table 28.	<ol style="list-style-type: none"> <li>1. Check the input line voltage (Procedure 2 on page 101).</li> <li>2. Reset the drive controller.</li> </ol>

**Table 27: Fault Codes and Messages** (continued)

Fault/Message	Probable Causes	Corrective Actions
<i>D E F</i> MOTOR OVERHEATING	Motor temperature too high.	<ol style="list-style-type: none"> <li>1. Check the motor ventilation, ambient temperature, and motor load.</li> <li>2. Check the type of thermal sensors used.</li> </ol>
<i>P H F</i> INPUT PHASE LOSS	<ul style="list-style-type: none"> <li>• Input phase loss.</li> <li>• Power fuses blown.</li> <li>• Input line failure (<math>t &gt; 1s</math>).</li> </ul>	<ol style="list-style-type: none"> <li>1. Check the input line voltage (Procedure 2 on page 101).</li> <li>2. Check the fuses and circuit breaker (Procedure 3 on page 102).</li> <li>3. Reset.</li> </ol>
<i>R n F</i> RAMP NOT FOLLOWED	<ul style="list-style-type: none"> <li>• Ramp not followed.</li> <li>• Motor rotation speed opposite from speed reference.</li> </ul>	<ol style="list-style-type: none"> <li>1. Check the adjustment and wiring of the speed feedback.</li> <li>2. Check the adjustments against the load.</li> <li>3. Check the sizing of the motor/drive controller combination. Dynamic Braking may be necessary.</li> </ol>
<i>S C F</i> MOT SHORT CKT	Short circuit or grounding on drive controller output.	<ol style="list-style-type: none"> <li>1. Remove all power. With the drive controller disconnected, check the connecting cables and motor insulation.</li> <li>2. Check the drive controller transistors.</li> </ol>
<i>S L F</i> LOSS OF RS485	Bad connection between the drive controller and the programming keypad display.	Check the connection between the drive controller and the programming keypad display.
<i>S O F</i> OVERSPEED	<ul style="list-style-type: none"> <li>• Instability</li> <li>• Overhauling load</li> </ul>	<ol style="list-style-type: none"> <li>1. Check parameter adjustments.</li> <li>2. Add dynamic braking.</li> <li>3. Verify the sizing of the motor, drive controller, and load.</li> </ol>
<i>S P F</i> SPEED FEEDBACK FAULT	Loss of speed feedback.	Check the wiring of the sensor.
<i>t S F</i> THERMAL SENSOR FAULT	Bad connection between the motor thermal sensors and the drive controller.	<ol style="list-style-type: none"> <li>1. Check the connection between the thermal sensors and the drive controller.</li> <li>2. Check the thermal sensors.</li> </ol>
<i>U S F</i> UNDERVOLTAGE	<ul style="list-style-type: none"> <li>• Supply is too low.</li> <li>• Temporary voltage drop (<math>t \geq 200 ms</math>).</li> </ul>	Check the input line voltage (Procedure 2 on page 101).

**Table 28: Overvoltage/Overbraking Trip and Reset Points**

	Overvoltage Trip Point	Overbraking Trip Point	Reset Point
ATV58***M2	395 Vdc	415 Vdc	385 Vdc
ATV58***N4	800 Vdc	840 Vdc	785 Vdc

**Table 29: Trip and Reset Points when Loss of 4–20 mA**

	Trip Point	Reset Point
ATV58***M2	AI2 < 2 mA	AI2 > 2.5 mA
ATV58***N4		



## APPENDIX A—DRIVE CONTROLLER CONFIGURATION

Use these pages to note the configuration and adjustments of the  
ATV58 TRX drive controller.

Drive catalog number: ATV58.....

Customer identification number: .....

Option card: No Yes Catalog number: .....

Access code: No Yes: .....

Configuration is in file number ..... of the programming terminal.

Macro-configuration: .....

Date of start-up .....

Drive controller serial number .....

For customized configuration (CUS), record assignments of  
inputs/outputs in Tables 30 to 35.

For a menu overview, see page 113.

The following tables list the factory setting for each parameter. The new customer setting can be noted in the Customer Setting column. If no change has been made to the factory setting, the customer can note “no change” in the Customer Setting column.

**Table 30: Menu 2—Adjustment Parameters**

Code	Fact. Setting	Cust. Setting	Code	Fact. Setting	Cust. Setting
<i>R C b</i>	no		<i>S P 6</i>	30 Hz	Hz
<i>R C C</i>	3 s	s	<i>S P 7</i>	35 Hz	Hz
<i>d E c</i>	3 s	s	<i>J O G</i>	10 Hz	Hz
<i>L S P</i>	0 Hz	Hz	<i>J G t</i>	0.5 s	s
<i>H S P</i>	50 / 60 Hz	Hz	<i>b r L</i>	0 Hz	Hz
<i>F L G</i>	20%	%	<i>I b r</i>	0 A	A
<i>S t R</i>	20%	%	<i>b r t</i>	0 s	s
<i>I t H</i>	0.9 of $I_n$	A	<i>b E n</i>	0 Hz	Hz
<i>I d C</i>	0.7 ItH	A	<i>b E t</i>	0 s	s
<i>t d C</i>	0.5 s	s	<i>F F t</i>	50/60 Hz	Hz
<i>S d C</i>	Varies	A	<i>r P G</i>	1	
<i>J P F</i>	0 Hz	Hz	<i>r I G</i>	1 / s	/s
<i>J F 2</i>	0 Hz	Hz	<i>P S P</i>	0.0 s	s
<i>J F 3</i>	0 Hz	Hz	<i>F b S</i>	0.1	
<i>R C 2</i>	5 s	s	<i>P I C</i>	no	
<i>d E 2</i>	5 s	s	<i>P I 2</i>	30%	%
<i>t L S</i>	no	no or s	<i>P I 3</i>	60%	%
<i>U S C</i>	1		<i>d t d</i>	105%	%
<i>U F r</i>	100%	%	<i>d t S</i>	1	
<i>S L P</i>	100%	%	<i>C t d</i>	1.36 of $I_n$	A
<i>P F L</i>	20%	%	<i>t t d</i>	100%	%
<i>S P 2</i>	10 Hz	Hz	<i>t L 2</i>	200%	%
<i>S P 3</i>	15 Hz	Hz	<i>F t d</i>	50/60 Hz	Hz
<i>S P 4</i>	20 Hz	Hz	<i>F 2 d</i>	50/60 Hz	Hz
<i>S P 5</i>	25 Hz	Hz			

**Table 31: Menu 3—Drive Menu Parameters**

Code	Fact. Setting	Cust. Setting	Code	Fact. Setting	Cust. Setting
<i>U n S</i>	depends on catalog number	V	<i>S t t</i>	STN	
<i>F r S</i>	50 / 60 Hz	Hz	<i>d C F</i>	4	
<i>n C r</i>	0.9 of $I_n$	A	<i>t L l</i>	200%	%
<i>n S P</i>	depends on catalog number	rpm	<i>C L l</i>	1.36 of $I_n$	
<i>C D S</i>	depends on catalog number		<i>R d C</i>	yes	
<i>t U n</i>	no		<i>P C C</i>	1	
<i>t F r</i>	60 / 72 Hz	Hz	<i>S F t</i>	LF	
<i>n L d</i>	no		<i>S F r</i>	depends on catalog number	kHz
<i>F d b</i>	no		<i>n r d</i>	yes	
<i>F r t</i>	0 Hz	Hz	<i>S P C</i>	no	
<i>r P t</i>	LIN		<i>P G t</i>	DET	
<i>b r R</i>	no		<i>P L S</i>	1024	

**Table 32: Menu 4—Command Menu Parameters**

Code	Fact. Setting	Cust. Setting	Code	Fact. Setting	Cust. Setting
<i>t C C</i>	2 W		<i>R D H</i>	20 mA	mA
<i>t C t</i>	LEL		<i>S t r</i>	no	
<i>r I n</i>	no		<i>L C C</i>	no	
<i>b S P</i>	no		<i>P S t</i>	yes	
<i>C r L</i>	4 mA	mA	<i>R d d</i>	0	
<i>C r H</i>	20 mA	mA	<i>t b r</i>	19200	
<i>R D L</i>	0 mA	mA	<i>r P r</i>	no	

**Table 33: Menu 5—I/O Assignment**

Code	Fact. Setting	Cust. Setting	Code	Fact. Setting	Cust. Setting
<i>R 1 1</i>	Factory settings depend on the macro-configuration. See page 23.		<i>L 1 5</i>	Factory settings depend on the macro-configuration. See page 23.	Fault
<i>R 1 2</i>			<i>L 1 6</i>		
<i>R 1 3</i>			<i>r 1</i>		
<i>L 1 1</i>			<i>r 2</i>		
<i>L 1 2</i>			<i>L 0</i>		
<i>L 1 3</i>			<i>R D 1</i>		
<i>L 1 4</i>			<i>R 0</i>		

**Table 34: Menu 6—Fault Menu Parameters**

Code	Fact. Setting	Cust. Setting	Code	Fact. Setting	Cust. Setting
<i>R L r</i>	no		<i>L F L</i>	no	
<i>n R r</i>	5		<i>L F F</i>	0	
<i>t R r</i>	30.0 s		<i>F L r</i>	no	
<i>r S t</i>	RSP		<i>S t P</i>	no	
<i>D P L</i>	yes		<i>S d d</i>	no	
<i>I P L</i>	yes		<i>E P L</i>	no	
<i>t H t</i>	ACL				

Use the table below to note what drive controller configuration is stored in a file.

**Table 35: Menu 7—File Menu**

Code	Factory Setting	Customer Notes (e.g. File stored for HVAC Drive #11)
<i>F 1 5</i>	Free	
<i>F 2 5</i>	Free	
<i>F 3 5</i>	Free	
<i>F 4 5</i>	Free	



### Menu Overview

#### Menu 1 – DISPLAY Menu (page 30)

Parameter	Code
Drive State	rDY
Steady State	rUn
Accelerating	ACC
Decelerating	dEc
I <sub>n</sub> Current Limit	CLi
DC Injection Braking	dCb
Freewheel Stop	nSt
Braking with Ramp Mod	ObR
Frequency Reference	LFr
LCU	LCU
Frequency Reference	FrH
Output Frequency	rFr
Motor Speed	SPd
Motor Current	LCr
Machine Speed	USP
Output Power	OPr
Mains Voltage	ULn
Motor Thermal	tHr
Drive Thermal	tHd
Last Fault	LFT
Consumption (wH)	APH
Run Time (Hours)	rTn

#### Menu 2 – ADJUST Menu (page 32)

Parameter	Code	Factory Setting
Frequency Reference	LFr	
LCU	LCU	0.00
Inv. Phases	ACb	no
Acceleration	-s ACC	3 s
Deceleration	-s dEC	3 s
Accelerate 2	-s AC2	5 s
Decelerate 2	-s dE2	5 s
Low Speed	-Hz LSP	0 Hz
High Speed	-Hz HSP	50 / 60 Hz
Gain	-% FLG	20%
Stability	-% StA	20%
Thermal Current	-A ItH	0.9 I <sub>n</sub>
DC Injection Time	-s tDC	0.5 s
DC Injection Curr	-A IdC	0.7 I <sub>th</sub>
DC Injection Curr	-A SdC	Varies
Jump Freq.	-Hz JPF	0 Hz
Jump Freq. 2	-Hz JF2	0 Hz
Jump Freq. 3	-Hz JF3	0 Hz
LSP Time	-s tLS	no
Machine Speed Coeff.	USC	1
IR Compensation	-% UFr	100%
Slip Comp.	-% SLP	100%
Preset Sp.2	-Hz SP2	10 Hz
Preset Sp.3	-Hz SP3	15 Hz
Preset Sp.4	-Hz SP4	20 Hz
Preset Sp.5	-Hz SP5	25 Hz
Preset Sp.6	-Hz SP6	30 Hz
Preset Sp.7	-Hz SP7	35 Hz
Frequency Lev.Att	-Hz FtD	50 / 60 Hz
Frequency Lev2.Att	-Hz F2d	
Torque Limit 2	-% tL2	200%
Current Level Att.	-A CtD	1.36 of I <sub>n</sub>
Brake Release Lev	-Hz brL	0 Hz
Brake Release I	-A Ibr	0 A
Brake ReleaseTime	-s brt	0 s

\* Requires addition of I/O option card  
VW3A58201U (analog) or VW3A58202U

#### Menu 2 – ADJUST Menu (page 32) (continued)

Parameter	Code	Factory Setting
Brake Engage Lev	-Hz bEn	0 Hz
Brake EngageTime	-s bEt	0 s
Trip Threshold NST	-Hz FFt	
Tachometer Coeff. *	dtS	1
Jog Freq.	-Hz JOG	10 Hz
Jog Delay	-s JGt	0.5 s
V/f Profile	-% PFL	20%
Thermal Level Att.	-% ttd	100%
PI Prop. Gain	rPG	1
PI Int. Gain	-/s rIG	1/s
PI Filter	PSP	0.0
PI Coeff	FbS	0.1
PI Inversion	PIC	no
PI Preset 2	% PI2	30%
PI Preset 3	% PI3	60%
ATV th. fault	dtD	105%

#### Menu 3 – DRIVE Menu (page 43)

Parameter	Code	Factory Setting
Nom. Motor Volt	-V UnS	depends on cat. #
Nom. Motor Freq.	-Hz FrS	50 / 60 Hz
Nom. Motor Curr	-A nCr	0.9 of I <sub>n</sub>
Nom. Motor Speed	-rpm nSP	depends on cat. #
Motor CosPhi (power fact.)	CoS	depends on cat. #
Auto Tuning	tUn	no
Max. Frequency	-Hz tFr	60 / 72 Hz
Energy Economy	nLd	no
I Limit Adapt.	Fdb	no
Dec Ramp Adapt	brA	no
Switch Ramp 2	-Hz Frt	0 Hz
Type of Stop	Stt	Stn
Standard Stop	Stn	
Fast Stop	FSt	
Freewheel	nSt	
DC Injection	DCI	
Ramp Type	rPt	LIn
Linear Ramp	LIn	
S Ramp	S	
U Ramp	U	
Dec Ramp Coef.	dCF	4
Torque Limit	-% tLI	200 %
Int. I Limit	-% CLI	1.36 of I <sub>n</sub>
Auto DC Inj.	AdC	yes
Mot. Power Coef.	PCC	1
Switching Freq. Type	SFT	LF
Range of 0.5 to 4 kHz	LF	depends on cat. #
Range of 4 to 16 kHz	HF1	depends on cat. #
High Duty Cycle w/ derat.	HF2	depends on cat. #
Sw. Freq 0.5 to16	-kHz SFr	0.5 to 16 kHz
Noise Reduction	nrd	yes
Special Motor	SFC	no
no		
yes		
PSM (small motor)		
PG (feedback sensor)Type *	PGt	dEt
Incremental Encoder	InC	
Detector (pulse or edge)	dEt	
Num. Pulses *	PLS	1

These diagrams include all parameters that may appear in the designated menu. The parameters actually visible on your drive controller depends on its configuration and the options installed.

**Menu 4 – CONTROL Menu (page 50)**

Parameter	Code	Factory Setting
Terminal Strip Con	tCC	2 W
Two Wire 2W	2 W	
Three Wire 3W	3 W	
Type 2 Wire	tCt	LEL
No Transition	LEL	
Low to High Trans.	TRN	
Forward Input Pri.	PfO	
Inhibit Reverse	rIn	
Low Speed Magmt	bSP	
Linear LSP to HSP	no	no
Pedestal Start	BLS	no
Deadband Start	BNS	
A12 Min. Ref.	-mA CrL	4 mA
A12 Max. Ref.	-mA CrH	20 mA
Min. Val. AO	-mA AOL	0 mA
Max. Val. AO	-mA AOH	20 mA
Reference Memory	Str	no
No memory	no	
Run Com. removed	RAM	
Power removed	EEP	
Keypad Com.	LCC	no
Stop Priority	PSt	yes
Drive Address	Add	0
Bd Rate RS485	tBr	
Reset Counters	rPr	

**Menu 5– I/O Menu (page 56)**

Parameter	Code	Factory Setting
LI2 Assign	LI2	
LI3 Assign	LI3	
LI4 Assign	LI4	
LI5 Assign *	LI5	
LI6 Assign *	LI6	
Not assigned	no	
RV: Reverse	RV	
Switch Ramp2	RP2	
JOG	JOG	
+SP: +Speed	SP	
-Speed	-SP	
2 preset Sp	PS2	
4 preset SP	PS4	
8 preset Sp	PS8	
Freewheel Stop	NST	
DC inject	OCI	
Fast stop	FSt	
Multi. Motor	CHP	
TorqueLim2	TL2	
Forced Local	FLO	
Fault Reset	rSt	
Auto/manu	RFC	
Auto-tune	Atn	
PI Auto/Man	PAU	
PI 2 Preset	Pr2	
PI 4 Preset	Pr4	
External flt	EDD	
Torque Limit by AI	tLA	

**Menu 5– I/O Menu (page 56) (continued)**

Parameter	Code	Factory Setting
A12 Assign	A12	
A13 Assign *	A13	
Not assigned	no	
Speed ref 2	Fr2	
Summed ref.	SAI	
PI regulator	PIF	
PI Manual Ref. *	PIH	
Tacho feedback *	SFb	
Therm. Sensor *	PtC	
Torque Limit *	AtL	
Encoder feedback *	RGI	
R2 Assign / LO assign	r2/LO	
Not assigned	no	
Drive running	rUn	
Output contactor	OCC	
Freq reference attain.	FtA	
HSP attained	FLA	
Current level attained	CtA	
Reference Freq. Attain.	SrA	
Motor thermal lvl (Attain)	tSA	
Brake logic	bLC	
4-20mA loss	APL	
F2 attained	F2A	
ATV th. alarm	TAD	
AO1 Assign	AO1	
AO Assign	AO	
Not assigned	no	
Motor current	OCr	
Motor frequency	OFr	
Output ramp	OrP	
Motor torque	trq	
Signed Torque	Stq	
Signed Ramp	OrS	
PI Reference	OPS	
PI Feedback	OPF	
PI Error	OPE	
PI Integral	OPI	
Motor Power	OPr	
Motor Thermal	tHr	
Drive Thermal	tHd	

\* Requires addition of I/O option card  
VW3A58201U (analog) or VW3A58202U (digital)

**Menu 6 – FAULT Menu (page 82)**

Parameter	Code	Factory Setting
Auto Restart	rAr	no
Nb max reset	nAr	5
Reset pause	-s tAr	30.0 s
Reset Type	rSt	RSP
Partial Reset	rSP	
Total Reset	rSG	
Output Phase Loss	OPL	yes
Input Phase Loss	IPL	yes
Thermal Protection	tHt	ACL
No motor protection	no	
Self Cooled motor	ACL	
Force Cooled motor	FCL	
Loss Follower	LFL	no
Immediate Fault	yes	
Restart on Signal Return	Stt	
Stop and Fault	LSF	
Run at Preset Speed	LFF	
Run at last speed	RLS	
Catch On Fly	FLr	no
Controlled Stop	StP	no
Phase loss drive trip	no	
Maintain DC Bus	MMS	
Follow ramp	FRP	
Ramp not Followed *	Sdd	no
External Fault	EPL	yes

\* Requires addition of I/O option card  
VW3A58201U (analog) or  
VW3A58202U (digital)

**Menu 7 – FILES Menu (page 86)**

Parameter	Code	Factory Setting
File 1 State	F1S	FRE
File 2 State	F2S	FRE
File 3 State	F3S	FRE
File 4 State	F4S	FRE
Operation Type	F0t	no
No Operation Req.	no	
Save Configuration	StR	
Transfer File to Drive	REC	
Return to Factory Set	Ini	
Password	Cod	0000



## APPENDIX B—OPTIONS AND ACCESSORIES

The following table shows the accessories available for ATV58 TRX drive controllers.

Catalog No.	Description
VW3A8104	PowerSuite™ Test & Commissioning Software on CD for use with Microsoft® Windows 95, 98, and NT™ and Windows CE v3.0 for Pocket PCs
VW3A8106	PC Connection Kit for connecting the PC to an ATV58 TRX controller. Kit includes: 1 m cable with RJ45 connectors; RS-232 to RS-485 adapter with RJ45 and DB9 female connectors; RJ45 to DB9 adapter for use with an ATV58 controller; and cable adapter for use with an ATV11 controller.
VW3A8111	Pocket PC Connection Kit for connecting a Jornada® PPC to an ATV58 TRX controller. Kit includes: 1/2 m cable with RJ45 connectors; RS-232 to RS-485 adapter with RJ45 and DB9 male connectors; RJ45 to DB9 adapter, cable adapter for use with an ATV11 controller, cable to connect the serial port on the PPC to the DB9 connector on the RS-232 to RS-485 adapter.
VW3A58101U	Keypad Display
VW3A58103	Remote Mounting Kit for Keypad (IP65 rated)
VW3A58201U	Analog I/O Option Card
VW3A58202U	Digital I/O Option Card
VW3A58210U	Pump Switching Card
VW3A58253U	General Purpose Option Card
VW3A58301U	Fipio® Communication Card
VW3A58302U	Modbus® Plus Communication Card
VW3A58303U	Modbus/Unitelway™ Communication Card
VW3A58304EU	Interbus S Communication Card. Requires external power supply.
VW3A58306U	RS-485 Cable w/ Modbus Mapping Guide
VW3A58307U	Profibus DP Communication Card
VW3A58309U	DeviceNet™ Communication Card
VW3A58310U	Ethernet Modbus TCP/IP Communication Card
VW3A58312PU	LONWORKS® to Modbus DIN Rail Mount Gateway
VW3A58354U	Johnson Controls® N2 Communication Card
VW3A58701	DB Transistor for ATV58HU09M2 and U18M2
VW3A58821	Fan Kit for ATV58HU09M2 and U18M2
VW3A58822	Fan Kit for ATV58HU29M2, U41M2, and U18N4 to U41N4
VW3A58823	Fan Kit for ATV58HU54M2, U72M2, and U54N4 to U90N4
VW3A58824	Fan Kit for ATV58HU90M2, D12M2, and D12N4 to D23N4
VW3A58825	Fan Kit for ATV58HD16M2, D23M2, and D28N4 to D46N4

Catalog No.	Description
VW3A58826	Fan Kit for ATV58HD28M2 to D46M2 and D54N4 to D79N4
VW3A58831	EMC Kit for ATV58HU09M2 and U18M2
VW3A58832	EMC Kit for ATV58HU29M2, U41M2, and U18N4 to U41N4
VW3A58833	EMC Kit for ATV58HU54M2, U72M2, and U54N4 to U90N4
VW3A58834	EMC Kit for ATV58HU90M2, D12M2, and D12N4 to D23N4
VW3A58842	Conduit Box Kit for ATV58HU09M2 and U18M2
VW3A58843	Conduit Box Kit for ATV58HU29M2, U41M2, and U18N4 to U41N4
VW3A58844	Conduit Box Kit for ATV58HU54M2, U72M2, and U54N4 to U90N4
VW3A58845	Conduit Box Kit for ATV58HU90M2, D12M2, and D12N4 to D23N4
VW3A58846	Conduit Box for ATV58HD16M2, D23M2, and D28N4 to D46N4
VW3A58847	Conduit Box for ATV58HD28M2 to D46M2 and D54N4 to D79N4
VW3A66711	DB Resistor Kit for ATV58HU09M2, U18M2, U18N4 to U72N4
VW3A66712	DB Resistor Kit for ATV58HU29M2, U41M2, U90N4, D12N4
VW3A66713	DB Resistor Kit for ATV58HU54M2, U72M2, D16N4, D23N4
VW3A66714	DB Resistor Kit for ATV58HU90M2, D12M2, and D28N4 to D46N4
VW3A66715	DB Resistor Kit for ATV58HD16M2, D23M2, D54N4
VW3A66716	DB Resistor Kit for ATV58HD28M2, D33M2, D46M2, D64N4, and D79N4

**Spare Part List for ATV58 TRX Controllers**

	Description	For Use on Drives	Catalog Number
	ATV58 TRX Control Board Kit	ATV58 Type H, 125–500 hp only	VX4A381U
		ATV58 Type E, F, H and N	VX4A581U
Internal fan kit	Frames 2 and 3 (two fans)	ATV58 ..U29M2, U41M2, U54M2, U72M2, U18N4, U29N4, U41N4, U54N4, U72N4, U90N4	VZ3V58223U
	Frames 4 and 5 (three fans)	ATV58 ..U90M2, D12M2, D12N4, D16N4, D23N4	VZ3V58245U
	Frame 6 (four fans)	ATV58 ..D16M2, D23M2, D28N4, D33N4, D46N4	VZ3V58260U
	Frame 7 (four fans)	ATV58 ..D28M2, D33M2, D46M2, D54N4, D64N4, D79N4	VZ3V58270U
Terminals	Removable ATV58 TRX Control Board Terminal Strips (includes relay terminal strip and 9- and 10-position terminal strips)	ATV58 Type E, F, H, and N	VZ3N581U
	Power Terminal Block for Frame 6	ATV58 ..D16M2, D28N4, D33N4	VZ3N58160U
		ATV58 ..D23M2, D46N4	VZ3N58165U
Power Terminal Block for Frame 7	ATV58 ..D28M2, D33M2, D46M2, D54N4, D64N4, D79N4	VZ3N58170U	
Internal EMC Filter Kit	Internal RFI Filter Kit for Frame 6	ATV58HD28N4	VX4A58861U
		ATV58HD33N4	VX4A58862U
		ATV58HD46N4	VX4A58863U
	Internal RFI Filter Kit for Frame 7	ATV58HD54N4	VX4A58871U
		ATV58HD64N4	VX4A58872U
		ATV58HD79N4	VX4A58873U
Power Boards for Frames 6 and 7	ATV58HD16M2	VX5A58D16M2U	
	ATV58HD23M2	VX5A58D23M2U	
	ATV58HD28M2	VX5A58D28M2U	
	ATV58HD33M2	VX5A58D33M2U	
	ATV58HD46M2	VX5A58D46M2U	
	ATV58HD28N4	VX5A58D28N4U	
	ATV58HD33N4	VX5A58D33N4U	
	ATV58HD46N4	VX5A58D46N4U	
	ATV58HD54N4	VX5A58D54N4U	
	ATV58HD64N4	VX5A58D64N4U	
ATV58HD79N4	VX5A58D79N4U		

	Description	For Use on Drives	Catalog Number
Power Components	Output Transistor Module	ATV58...D28N4	VZ3IM6075M1258U
		ATV58...D16M2, D33N4	VZ3IM6100M1258U
		ATV58...D23M2, D28M2, D46N4, D54N4	VZ3IM6150M1258U
		ATV58...D33M2, D46M2, D64N4, D79N4	VZ3IM2200M1258U
	Dynamic Braking Transistor	ATV58...D16M2, D23M2, D28N4, D33N4, D46N4	VZ3IM1050M1258U
		ATV58...D28M2, D54N4	VZ3IM1100M1258U
		ATV58...D33M2, D46M2, D64N4, D79N4	VZ3IM1150M1258U
	Input Diode / Transistor Bridge	ATV58...D16M2, D28N4, D33N4	VZ3TD1055M1658U
		ATV58...D23M2, D28M2, D46N4, D54N4	VZ3TD1090M1658U
		ATV58...D33M2, D46M2, D64N4, D79N4	VZ3TD1130M1658U

Factory repaired ATV58 TRX drive controllers are available within 24 hours from a factory exchange pool, or your ATV58 TRX drive controller can be factory repaired and returned. Contact your local Square D distributor or Square D Customer Service Representative at 919-266-8666 for availability.



## INDEX

### Symbols

+SP 59  
+speed/-speed 66

### Numerics

2-wire control 53, 65  
3-wire control 52, 65  
50/60 Hz switch 13

### A

AC2 41, 46, 62  
ACb 31  
ACC 28, 31  
acceleration ramp 31  
access code 19, 92  
access locking switch 18–19  
ACL 87  
AdC 49  
Add 57  
address 57  
analog inputs  
  assignable functions 59  
  use of 74  
analog outputs  
  assignable functions 61  
  use of 81  
AnF 106  
AOH 55  
AOL 55  
APH 28  
APL 61, 81  
ATL 60  
ATN 60  
Atr 85  
auto-manual. See reference  
switching  
automatic restart 85  
Auto-tuning 42, 45, 73

### B

bEn 40, 62, 79  
bEt 40, 62, 79  
BLC 61–62  
bLC 78  
BLS 54  
BnS 54  
brA 46

brake logic 78  
  brake engage frequency 40,  
  79  
  brake engage time 40, 79  
  brake release current 39, 79  
  brake release frequency 39,  
  79  
  brake release time 40, 79  
brL 39, 62, 79  
brt 40, 62, 79  
bSP 54  
bus voltage measurement 98

### C

catch on the fly 88  
CFF 103  
CFI 103  
CHP 59, 63  
CLI 28, 49  
CnF 85–86, 103  
coast to stop. See freewheel  
stop  
COd 90, 92  
communication network fault  
103  
communication option card 19,  
94  
configuration  
  saving of 90  
  transferring 90  
configuration fault 103  
CoS 44–45  
cos phi 44  
CrF 103  
CrH 55, 88  
CrL 55, 88  
CTA 61–62  
CtA 78  
Ctd 36, 41, 62, 78  
current  
  nominal motor 43  
  threshold 41, 78  
current limit 41, 49  
custom configuration 26  
customer application card 19,  
94

### D

dc injection braking 49, 70, 77  
  current level 38  
  time 32  
dCb 28  
dCF 48, 63, 71  
DCI 59, 62  
dE2 41, 46, 62, 89  
dEC 28, 31, 89  
deceleration ramp 31  
deceleration ramp adaptation  
46  
drive overheating 105  
drive run relay 77  
drive thermal threshold at-  
tained 81  
dtd 40, 63  
dtS 41, 62

### E

EDD 60  
EEF 103  
EEP 56  
EEPROM fault 103  
energy savings 46  
EnG 90  
EPF 85–86, 103  
external fault 103

### F

F1S 90  
F2A 61, 63, 81  
F2d 40, 63, 81  
F2S 90  
F3S 90  
F4S 90  
factory settings  
  returning to 90  
  see macro-configuration  
fast stop 71  
  deceleration ramp coefficient  
  48  
faults  
  codes and messages 103  
  external 73  
  resetting 72, 86, 95  
  partial 72  
  total 72  
FbS 40, 62

FCL 87  
Fdb 46  
FFt 33  
FLA 61, 78  
FLG 31  
FLO 59  
FLr 88  
force to local 73  
forward 65  
FOt 90, 92  
FR2 60  
FRE 90  
freewheel stop 70  
frequency  
  jump 33  
  loop gain 31  
  maximum 45  
  nominal motor 43  
  reference attained 78  
  threshold 40  
  threshold attained 77  
frequency threshold 2 attained  
81  
FrH 28–29  
FRP 89  
FrS 43  
Frt 41, 46  
FST 59, 63  
FTA 61–62  
FtA 77  
Ftd 40, 62, 77  
**G**  
GEn 23, 42  
**H**  
Hdg 23, 42  
HF1 49  
HF2 49  
high speed 31  
high speed attained 78  
HSP 31  
**I**  
I/O extension card 7, 30  
I/O option card 7  
lbr 39, 62, 79  
ldC 38, 41, 62  
lLF 104  
InF 104

Ini 90  
input phase loss 87, 106  
internal communication fault  
104  
internal fault 104  
IPL 87, 89  
IR compensation 35, 37, 42  
ItH 32  
**J**  
JF2 33  
JF3 34  
JGt 37, 39, 62, 66  
JOG 37, 39, 59, 62, 66  
jog 66  
  delay 37, 39  
  frequency 37, 39  
JPF 33  
jump frequency 33  
**K**  
keypad  
  command 56  
  connections 18  
  function of keys 15  
  keys  
    arrows 15  
    ENT 15  
    ESC 15  
    FWD/REV 15  
    RUN 15  
    STOP 57  
    STOP/RESET 15  
  mounting 12  
  remote mounting 12  
**L**  
language 23  
LCC 29–30, 56, 73  
LCr 28  
LCU 29–30  
LEDs 95  
LEL 53  
LF 49  
LFF 85–86, 88, 105  
LFL 88  
LFr 29–30, 56  
LFt 28

logic inputs  
  assignable functions 59  
  use of 65  
logic outputs  
  use of 77  
loss of 4–20 mA follower 88,  
105  
loss of 4–20 mA signal 81  
low speed 31  
LSP 31  
**M**  
macro-configuration 23, 30  
  general use 23, 37  
  material handling 23, 35  
  modification 25  
  variable torque 23, 38  
mechanical brake 78  
menus  
  adjust 29  
  adjustment 18, 62  
  application 94  
  command 19  
  communication 19, 94  
  control 52, 63  
  display 18, 28  
  drive 19, 41, 63  
  fault 19, 63, 85  
  file 19  
  files 89  
  hierarchy 19  
  I/O 58  
  I/O assignment 19  
  identification 26  
  language 18, 21  
  macro-configuration 18–19,  
23  
MMS 89  
motor overheating 106  
motor overload 105  
motor phase loss 105  
motor switching 49, 71  
motor thermal protection  
  current 32  
  types 87  
multiple motors. See motor  
switching

## N

nAr 86  
nCr 43  
nLd 46  
NO 59, 61  
noise reduction 50  
nrd 50  
nSP 28, 35, 43  
NST 59, 70  
nSt 28

## O

Obf 46, 85–86, 105  
Obr 28  
OCC 61, 77  
OCR 105  
OCR 61  
OFR 61  
OHF 28, 85–86, 105  
OLF 85–86, 105  
OPE 61  
OPF 61, 85–86, 105  
OPI 62  
OPL 77, 87  
OPR 62  
Opr 28  
OPS 61  
ORP 61  
ORS 61  
OSF 85–86, 105  
OtF 85–86, 106  
output contactor command 77  
output phase loss 87  
overbraking 105  
overcurrent 105  
overvoltage 105

## P

P12 62  
P13 62  
parallel motor operation. See special motors  
password. See access code  
PAU 60  
PCC 49, 63, 71  
PFL 38  
PFW 53  
PGt 51, 63  
PHF 106

PI regulator 74  
    feedback scaling factor 40  
    integral gain 40  
    proportional gain 40  
PI2 40  
PI3 40  
PIC 40, 62  
PIF 60, 62  
PIM 60  
PLS 51, 63  
power factor. See cos phi  
PR2 60  
PR4 60, 62  
precharge fault 103  
preset speeds 35–36, 39, 69  
programming  
    principles 21  
PS2 59  
PS4 59, 62  
PS8 59, 62  
PSP 40  
PSt 57  
PTC 60  
pushbuttons 66

## R

RAM 56  
ramp not followed 106  
ramp switching 66  
ramps  
    second ramp 46  
    types 48  
rdY 28  
REC 90–91  
reference summing 74  
reference switching 70  
relay output  
    assignable functions 61  
reverse 65  
RFC 59  
rFr 28  
RGI 60, 63  
rIG 40, 62  
rIn 53  
RnF 86  
RP2 59, 62, 66  
rPG 40, 62  
rPr 58  
rPt 48

RS485 link 57  
RSG 72, 86  
RSP 72, 86  
RST 59, 63  
rSt 63, 72, 86  
rH 29  
RUN 61, 77  
rUn 28  
Run Permissive 70  
RV 59

## S

SAI 60, 63  
SCF 72, 106  
Sdc 33  
Sdd 63, 89  
selector switch 67–68  
serial link fault 12, 106  
SFB 60, 62–63  
SFr 45, 50  
SFt 49  
skip frequency  
    see jump frequency 33  
SLF 56, 85–86, 106  
slip compensation 35, 37  
SLP 35, 37  
SOF 86, 106  
-SP 59, 63  
SP2 35–36, 39, 62  
SP3 35–36, 39, 62  
SP4 39, 62  
SP5 39, 62  
SP6 39, 62  
SP7 39, 62  
SPC 35, 37, 42, 50  
SPd 28  
special motors 42, 50  
speed  
    nominal motor 43  
    speed feedback fault 106  
SPF 106  
SRA 61  
SrA 78  
StA 32  
stability 32  
start-up  
    minimum 17  
StP 89  
STQ 61

STR 90–91  
Str 56, 63, 67  
Stt 47  
switching frequency 49  
synchronous motor operation.  
See special motors

## T

TAD 63  
tAd 61, 81  
tAr 86  
tbr 58  
tCC 52  
tCt 53  
tdC 32  
terminal strip configuration 52  
tFr 45  
THD 62

tHd 28  
thermal sensor fault 106  
thermal state attained 78  
thermal state detection 41  
THR 62  
tHr 28  
tHt 87  
TL2 59, 62  
tL2 41, 62  
TLA 60  
tLI 49  
tLS 34  
torque limit 72  
TrN 53  
TRQ 61  
TSA 61–62  
tSA 78  
tSF 106

ttd 41, 62  
tUn 45

## U

UFr 35, 37, 42  
ULn 28  
undersized motors 42, 50  
UnS 43  
USC 34  
USF 89, 106  
USp 28

## V

V/f profile 38  
voltage  
  nominal motor 43  
VT 23



**Altivar® 58 TRX Keypad Display VW3A58101**  
**Instruction Bulletin**

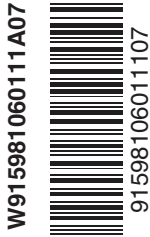

**Schneider Electric**  
8001 Highway 64 East  
Knightdale, NC 27545 USA  
1-888-SquareD (1-888-778-2733)  
[www.SquareD.com](http://www.SquareD.com)

Electrical equipment should be installed, operated, serviced, and maintained only by qualified personnel. No responsibility is assumed by Schneider Electric for any consequences arising out of the use of this material.

VVDED397047USR6/03  
© 1998–2003 Schneider Electric All Rights Reserved

06/2003

[efesotomasyon.com](http://efesotomasyon.com)