

Altivar 61/71/LIFT

Variable speed drives
for synchronous and asynchronous motors

Safety integrated function manual

01/2012



The information provided in this documentation contains general descriptions and/or technical characteristics of the performance of the products contained herein. This documentation is not intended as a substitute for and is not to be used for determining suitability or reliability of these products for specific user applications. It is the duty of any such user or integrator to perform the appropriate and complete risk analysis, evaluation and testing of the products with respect to the relevant specific application or use thereof. Neither Schneider Electric nor any of its affiliates or subsidiaries shall be responsible or liable for misuse of the information contained herein. If you have any suggestions for improvements or amendments or have found errors in this publication, please notify us.

No part of this document may be reproduced in any form or by any means, electronic or mechanical, including photocopying, without express written permission of Schneider Electric.

All pertinent state, regional, and local safety regulations must be observed when installing and using this product. For reasons of safety and to help ensure compliance with documented system data, only the manufacturer should perform repairs to components.

When devices are used for applications with technical safety requirements, the relevant instructions must be followed.

Failure to use Schneider Electric software or approved software with our hardware products may result in injury, harm, or improper operating results.

Failure to observe this information can result in injury or equipment damage.

© 2012 Schneider Electric. All rights reserved.

Table of contents



| | | |
|------------------|--|-----------|
| | Safety Information | 5 |
| | About the book | 7 |
| Chapter 1 | Before you begin | 9 |
| | Safety instructions | 10 |
| | Qualification of personnel and use | 12 |
| Chapter 2 | Overview | 13 |
| | Introduction | 14 |
| | Standards and Terminology | 15 |
| | Basics | 16 |
| Chapter 3 | Description | 19 |
| | PWR (STO) Safe Torque Off | 20 |
| Chapter 4 | Incompatibility with safety functions | 21 |
| | Limitations | 22 |
| Chapter 5 | Safety monitoring | 25 |
| | Power Removal Safety Function | 26 |
| Chapter 6 | Technical data | 27 |
| | Electrical Data | 28 |
| | Safety function capability | 29 |
| | Two certified architectures | 31 |
| | Process system SF - Case 1 | 32 |
| | Process system SF - Case 2 | 33 |
| | Process system SF - Case 3 | 35 |
| Chapter 7 | Appendix | 37 |
| | ATV61 Product sizes | 38 |
| | ATV71 Product sizes | 42 |

Safety Information

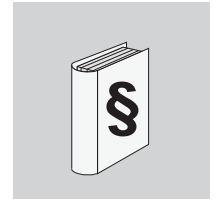

Important Information

NOTICE

Read these instructions carefully, and look at the equipment to become familiar with the device before trying to install, operate, or maintain it. The following special messages may appear throughout this documentation or on the equipment to warn of potential hazards or to call attention to information that clarifies or simplifies a procedure.



The addition of this symbol to a Danger or Warning safety label indicates that an electrical hazard exists, which will result in personal injury if the instructions are not followed.



This is the safety alert symbol. It is used to alert you to potential personal injury hazards. Obey all safety messages that follow this symbol to avoid possible injury or death.

⚠ DANGER

DANGER indicates an imminently hazardous situation, which, if not avoided, **will result** in death or serious injury.

⚠ WARNING

WARNING indicates a potentially hazardous situation, which, if not avoided, **can result** in death, serious injury or equipment damage.

⚠ CAUTION

CAUTION indicates a potentially hazardous situation, which, if not avoided, **can result** in injury or equipment damage.

NOTICE

NOTICE, used without the safety alert symbol, indicates a potentially hazardous situation which, if not avoided, **can result** in equipment damage.

PLEASE NOTE

The word "drive" as used in this manual refers to the controller portion of the adjustable speed drive as defined by NEC.

Electrical equipment should be installed, operated, serviced, and maintained only by qualified personnel. No responsibility is assumed by Schneider Electric for any consequences arising out of the use of this product.

© 2011 Schneider Electric. All Rights Reserved.

About the book

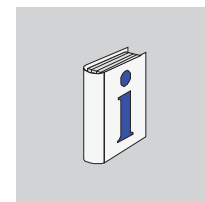

At a Glance

Document Scope

The purpose of this document is to provide information about safety functions incorporated in Altivar 61/71/ LIFT. These functions allow you to develop applications oriented in the protection of man and machine. Please, read before the installation and programming manual.

Validity Note

This documentation is valid for the Altivar 61, Altivar 71, Altivar LIFT, Altivar 61Q, Altivar 71Q, Altivar 61 Plus and Altivar 71 Plus drives.

Related Documents

| Title of Documentation | Reference Number |
|---|------------------|
| ATV61E installation manual 55 kW (75 HP) ... 90 kW (125 HP) / 200 - 240 V 90 kW (125 HP) ... 630 kW (900 HP) / 380 - 480 V 90 kW (125 HP) ... 800 kW (800 HP) / 500 - 690 V | 760655 |
| ATV71E Installation manual 55 kW (75 Hp) ... 75 kW (100 Hp) / 200 - 240 V 90 kW (125 Hp) ... 500 kW (700 Hp) / 380 - 480 V 90 kW (125 Hp) ... 630 kW (700 Hp) / 500 - 690 V | 755849 |
| ATV61S Installation manual 0.37 kW (0.5 HP) ... 45 kW (60 HP) / 200 - 240 V 0.75 kW (1 HP) ... 75 kW (100 HP) / 380 - 480 V 2.2 kW (3 HP) ... 7.5 kW (10 HP) / 500 - 600 V 2.2 kW (3 HP) ... 90 kW (100 HP) / 500 - 690 V | 760643 |
| ATV71S Installation manual 0.37 (0.5 HP) ... 45 kW (60 HP) / 200 - 240 V 0.75 (1 HP) ... 75 kW (100 HP) / 380 - 480 V 1.5 (2 HP) ... 7.5 kW (10 HP) / 500 - 600 V 1.5 (2 HP) ... 90 kW (100 HP) / 500 - 690 V | 755843 |
| ATV61Q Mounting instructions 110 kW (150HP) ... 630 kW (800HP) / 380 - 480 V 110 kW (150HP) ... 800 kW (800HP) / 500 - 690 V | 8P02534 |
| ATV71Q Mounting instructions 90 kW (125HP) ... 500 kW (700HP) / 380 - 480 V 90 kW (125HP) ... 630 kW (700HP) / 500 - 690 V | 8P02535 |
| ATV61 Plus Configuration Guide 90 kW ... 1400 kW / 380 - 415 V 90 kW ... 1800 kW / 500 - 525 V 110 kW ... 2400 kW / 690 V | 8P02503 |
| ATV71 Plus Configuration Guide 90 kW ... 1300 kW / 380 - 415 V 90 kW ... 1500 kW / 500 - 525 V 110 kW ... 2000 kW / 690 V | 8P02504 |
| ATV61 Plus-Marine 630 kW ... 1400 kW / 380 - 415 V 800 kW ... 2400 kW / 690 V | 8P02526 |

| Title of Documentation | Reference Number |
|---|-------------------------|
| ATV71 Plus-Marine 500 kW ... 1300 kW / 380 - 415 V 630 kW ... 2000 kW / 690 V | 8P02527 |
| ATV61_71 Atex manual | AAV49434 |
| ATV61 Programming manual | 760649 |
| ATV71 Programming_manual | 755855 |
| ATV_LIFT programming manual | BBV19478 |
| ATV61_71 Canopen manual | 755865 |
| ATV61_71 Cc-link manual | AAV49429 |
| ATV61_71 Ethernet manual | 755879 |
| ATV61_71 Ethernet TCP Daisy Chain manual | AAV69931 |
| ATV61_71 EthernetIP manual | AAV68822 |
| ATV61_71 FIPIO manual | 755883 |
| ATV61_71 Interbus manual | 755871 |
| ATV61_71 PROFIBUS DPv1 manual | AAV52935 |
| ATV61 Apogee FLN P1 manual | BBV10543 |
| ATV61 Bacnet manual | 765274 |
| ATV61 LonWorks_manual | 765273 |
| ATV61 metasys N2 manual | AAV33578 |
| ATV61 multi pump manual | 765272 |
| ATV61 communication parameters | 760661 |
| ATV71 communication parameters | 755861 |
| ATV71 Controller inside manual | 757062 |
| ATV71 Devicenet manual | 755877 |
| ATV71 Modbus integrated manual | 755863 |
| ATV71 Modbus jbus manual | 755875 |
| ATV71 Modbus plus manual | 755869 |
| ATV71 profibus manual | 755873 |
| ATV71 regen units manual | 757361 |
| ATV71 Uni-Telway manual | 755867 |
| ATV61 and 71 other option manuals: see www.schneider-electric.com . | |

You can download the latest versions of the technical publications related to the Altivar 61 and 71 on www.schneider-electric.com.

Before you begin



1

What's in this Chapter?

This chapter contains the following topics:

| Topic | Page |
|------------------------------------|------|
| Safety instructions | 10 |
| Qualification of personnel and use | 12 |

Safety instructions

The information provided in this manual supplements the product manuals.

Carefully read the product manuals before using the product.

Read and understand these instructions before performing any procedure with this drive.

DANGER

HAZARD OF ELECTRIC SHOCK, EXPLOSION, OR ARC FLASH

- Read and understand this manual before installing or operating the drive. Installation, adjustment, repair, and maintenance must be performed by qualified personnel.
- The user is responsible for compliance with all international and national electrical code requirements with respect to grounding of all equipment.
- Many parts of this drive, including the printed circuit boards, operate at the line voltage. DO NOT TOUCH. Use only electrically insulated tools.
- DO NOT touch unshielded components or terminal strip screw connections with voltage present.
- DO NOT short across terminals PA and PB or across the DC bus capacitors.
- Before servicing the drive:
 - Disconnect all power, including external control power that may be present.
 - Place a "DO NOT TURN ON" label on all power disconnects.
 - Lock all power disconnects in the open position.
 - WAIT 15 MINUTES to allow the DC bus capacitors to discharge.
 - Measure the voltage of the DC bus between the PA and PB terminals to ensure that the voltage is less than 42 Vdc.
 - If the DC bus capacitors do not discharge completely, contact your local Schneider Electric representative. Do not repair or operate the drive.
- Install and close all covers before applying power or starting and stopping the drive.

Failure to follow these instructions will result in death or serious injury.

DANGER

UNINTENDED EQUIPMENT OPERATION

- Read and understand this manual before installing or operating the drive.
- Any changes made to the parameter settings must be performed by qualified personnel.

Failure to follow these instructions will result in death or serious injury.

WARNING

DAMAGED DRIVE EQUIPMENT

Do not operate or install any drive or drive accessory that appears damaged.

Failure to follow these instructions can result in death, serious injury, or equipment damage.

⚠ WARNING

LOSS OF CONTROL

- The designer of any wiring scheme must consider the potential failure modes of control channels and, for certain critical control functions, provide a means to achieve a safe state during and after a channel failure. Examples of critical control functions are emergency stop and overtravel stop.
- Separate or redundant control channels must be provided for critical control functions.
- Each implementation of a control system must be individually and thoroughly tested for proper operation before being placed into service.
- System control channels may include links carried out by the communication. Consideration must be given to the implications of unanticipated transmission delays or failures of the link¹.

Failure to follow these instructions can result in death, serious injury, or equipment damage.

1. For additional information, refer to NEMA ICS 1.1 (latest edition), "Safety Guidelines for the Application, Installation, and Maintenance of Solid State Control" and to NEMA ICS 7.1 (latest edition), "Safety Standards for Construction and Guide for Selection, Installation and Operation of Adjustable-Speed Drive Systems."

⚠ CAUTION

INCOMPATIBLE LINE VOLTAGE

Before turning on and configuring the drive, ensure that the line voltage is compatible with the supply voltage range shown on the drive nameplate. The drive may be damaged if the line voltage is not compatible.

Failure to follow these instructions can result in injury or equipment damage.

NOTICE

RISK OF DERATED PERFORMANCE DUE TO CAPACITOR AGING

The product capacitor performances after a long time storage above 2 years can be degraded. In that case, before using the product, apply the following procedure:

- Use a variable AC supply connected between L1 and L2 (even for ATV61/71●●●N4 references).
- Increase AC supply voltage to have:
 - 25% of rated voltage during 30 min
 - 50% of rated voltage during 30 min
 - 75% of rated voltage during 30 min
 - 100% of rated voltage during 30 min

Failure to follow these instructions can result in equipment damage.

Qualification of personnel and use

Qualification of personnel

Only appropriately trained persons who are familiar with and understand the contents of this manual and all other pertinent product documentation are authorized to work on and with this product. In addition, these persons must have received safety training to recognize and avoid hazards involved. These persons must have sufficient technical training, knowledge and experience and be able to foresee and detect potential hazards that may be caused by using the product, by changing the settings and by the mechanical, electrical and electronic equipment of the entire system in which the product is used.

All persons working on and with the product must be fully familiar with all applicable standards, directives, and accident prevention regulations when performing such work.

Intended use

The functions described in this manual are only intended for use with the basic product; you must read and understand the appropriate product manual.

The product may only be used in compliance with all applicable safety regulations and directives, the specified requirements and the technical data.

Prior to using the product, you must perform a risk assessment in view of the planned application. Based on the results, the appropriate safety measures must be implemented.

Since the product is used as a component in an entire system, you must ensure the safety of persons by means of the design of this entire system (for example, machine design).

Operate the product only with the specified cables and accessories. Use only genuine accessories and spare parts.

Any use other than the use explicitly permitted is prohibited and can result in hazards.

Electrical equipment should be installed, operated, serviced, and maintained only by qualified personnel.

The product must NEVER be operated in explosive atmospheres (hazardous locations, Ex areas).

Overview



2

What's in this Chapter?

This chapter contains the following topics:

| Topic | Page |
|---------------------------|------|
| Introduction | 14 |
| Standards and Terminology | 15 |
| Basics | 16 |

Introduction

The safety function incorporated in Altivar 61/71/LIFT, allows you to develop applications oriented in the protection of man and machine.

Safety integrated function provides the following benefits:

- Replacement of external safety equipment
- Reduced wiring efforts and space requirements
- Reduced costs

The Altivar 61/71/LIFT drives are compliant with normative requirements to implement the safety function

Safety function as per IEC 61800-5-2

PWR (STO) Power Removal (Safe Torque Off)

The function purpose is to bring the motor into a no torque condition so it is relevant in terms of safety since no torque is available at the motor level. Power modules are inhibited and the motor coasts down or prohibits the motor from starting.

Notation

The graphic display terminal (reference VW3 A1 101) menus are shown in square brackets.

Example: **[COMMUNICATION]**

The integrated 7-segment display terminal menus are shown in round brackets.

Example: **(C D Π -)**

Parameter names are displayed on the graphic display terminal in square brackets.

Example: **[Fallback speed]**

Parameter codes are displayed on the integrated 7-segment display terminal in round brackets.

Example: **(L F F)**

Standards and Terminology

Technical terms, terminology and the corresponding descriptions in this manual are intended to use the terms or definitions of the pertinent standards.

In the area of drive systems, this includes, but is not limited to, terms such as "safety function", "safe state", "fault", "fault reset", "failure", "error", "error message", "warning", "warning message", etc.

Among others, these standards include:

- IEC 61800 series: "Adjustable speed electrical power drive systems"
- IEC 61508 series Ed.2: "Functional safety of electrical/electronic/programmable electronic safetyrelated systems"
- EN 954-1 Safety of machinery - Safety related parts of control systems
- EN ISO 13849-1 & 2 Safety of machinery - Safety related parts of control systems

EC Declaration of Conformity

The EC Declaration of Conformity for the EMC Directive can be obtained on www.schneider-electric.com

ATEX certification

The ATEX certificate can be obtained on www.schneider-electric.com

Certification for functional safety

The integrated safety function is compatible and certified following IEC 61800-5-2 Ed.1 Adjustable speed electrical power drive systems – Part 5-2 : Safety requirements – Functional

IEC 61800-5-2 as a product standard, sets out safety-related considerations of Power Drive Systems Safety Related "PDS (SR) s" in terms of the framework of IEC 61508 series Ed.2 of standards.

Compliance with IEC 61800-5-2 standard, for the following described safety function, will facilitate the incorporation of a PDS(SR) (Power Drive System with safety-related functions) into a safety-related control system using the principles of IEC 61508, or the ISO 13849-1, as well as the IEC 62061 for process-systems and machinery.

The defined safety function is:

- SIL 2 capability in compliance with IEC 61800-5-2 and IEC 61508 series Ed.2.
- Performance Level "d" in compliance with ISO 13849-1.
- Compliant with the Category 3 and 4 of European standard ISO 13849-1 (EN 954-1).

Also refer to Safety function capability, page [29](#).

The safety demand mode of operation is considered in high demand or continuous mode of operation according to the IEC 61800-5-2 standard.

The certificate for functional safety is accessible on www.schneider-electric.com.

Basics

Functional Safety

Automation and safety engineering are two areas that were completely separated in the past but recently have become more and more integrated.

Engineering and installation of complex automation solutions are greatly simplified by integrated safety functions.

Usually, the safety engineering requirements depend on the application.

The level of the requirements results from the risk and the hazard potential arising from the specific application.

IEC 61508 standard

The standard IEC 61508 "Functional safety of electrical/electronic /programmable electronic safety-related systems" covers the safety-related function. Instead of a single component, an entire function chain (for example, from a sensor through the logical processing units to the actuator) is considered as a unit. This function chain must meet the requirements of the specific safety integrity level as a whole. Systems and components that can be used in various applications for safety tasks with comparable risk levels can be developed on this basis.

SIL - Safety Integrity Level

The standard IEC 61508 defines 4 safety integrity levels (SIL) for safety functions. SIL1 is the lowest level and SIL4 is the highest level. A hazard and risk analysis serves as a basis for determining the required safety integrity level. This is used to decide whether the relevant function chain is to be considered as a safety function and which hazard potential it must cover.

PFH - Probability of a dangerous Hardware Failure per Hour

To maintain the safety function, the IEC 61508 standard requires various levels of measures for avoiding and controlling detected faults, depending on the required SIL. All components of a safety function must be subjected to a probability assessment to evaluate the effectiveness of the measures implemented for controlling detected faults. This assessment determines the PFH (probability of a dangerous failure per hour) for a safety system. This is the probability per hour that a safety system fails in a hazardous manner and the safety function cannot be correctly executed. Depending on the SIL, the PFH must not exceed certain values for the entire safety system. The individual PFH values of a function chain are added. The result must not exceed the maximum value specified in the standard.

| SIL Safety Integrity Level | Probability of a dangerous Failure per Hour (PFH) at high demand or continuous demand |
|----------------------------|---|
| 4 | $\geq 10^{-9}$... $< 10^{-8}$ |
| 3 | $\geq 10^{-8}$... $< 10^{-7}$ |
| 2 | $\geq 10^{-7}$... $< 10^{-6}$ |
| 1 | $\geq 10^{-6}$... $< 10^{-5}$ |

PL - Performance level

The standard IEC 13849-1 defines 5 Performance levels (PL) for safety functions. "a" is the lowest level and "e" is the highest level. Five level (a, b, c, d, e) correspond to different values of average probability of dangerous failure per hour.

| Performance level | Probability of a dangerous Hardware Failure per Hour |
|-------------------|--|
| e | $\geq 10^{-8}$... $< 10^{-7}$ |
| d | $\geq 10^{-7}$... $< 10^{-6}$ |
| c | $\geq 10^{-6}$... $< 3 \cdot 10^{-6}$ |
| b | $\geq 3 \cdot 10^{-6}$... $< 10^{-5}$ |
| a | $\geq 10^{-5}$... $< 10^{-4}$ |

HFT - hardware detected fault tolerance and SFF - Safe Failure Fraction

Depending on the SIL for the safety system, the IEC 61508 standard *and SFF, Safe Failure Fraction* requires a specific hardware detected fault tolerance HFT in connection with a specific proportion of safe failures SFF (safe failure fraction).

The hardware detected fault tolerance is the ability of a system to execute the required safety function in spite of the presence of one or more hardware detected faults.

The SFF of a system is defined as the ratio of the rate of safe failures to the total failure rate of the system.

According to IEC 61508, the maximum achievable SIL of a system is partly determined by the hardware detected fault tolerance HFT and the safe failure fraction SFF of the system.

IEC 61508 distinguishes two types of subsystems (type A subsystem, type B subsystem). These types are specified on the basis of criteria which the standard defines for the safety-relevant components.

| SFF | HFT type A subsystem | | | HFT type B subsystem | | |
|---------------|----------------------|------|------|----------------------|------|------|
| | 0 | 1 | 2 | 0 | 1 | 2 |
| < 60% | SIL1 | SIL2 | SIL3 | --- | SIL1 | SIL2 |
| 60% ... < 90% | SIL2 | SIL3 | SIL4 | SIL1 | SIL2 | SIL3 |
| 60% ... < 99% | SIL3 | SIL4 | SIL4 | SIL2 | SIL3 | SIL4 |
| u 99% | SIL3 | SIL4 | SIL4 | SIL3 | SIL4 | SIL4 |

Detected fault avoidance measures

Systematic errors in the specifications, in the hardware and the software, usage detected faults and maintenance detected faults of the safety system must be avoided to the maximum degree possible. To meet these requirements, IEC 61508 specifies a number of measures for detected fault avoidance that must be implemented depending on the required SIL. These measures for detected fault avoidance must cover the entire life cycle of the safety system, i.e. from design to decommissioning of the system.

Description



3

What's in this Chapter?

This chapter contains the following topics:

| Topic | Page |
|---------------------------|------|
| PWR (STO) Safe Torque Off | 20 |

PWR (STO) Safe Torque Off

The purpose of this function is to bring the motor into a no torque condition with motor coasts down or prohibits the motor from starting. So it is relevant in terms of safety since no torque is available at the motor level.

The logic input "PWR (STO)" is always assigned to this function.

The PWR (STO) status is accessible with the drive.

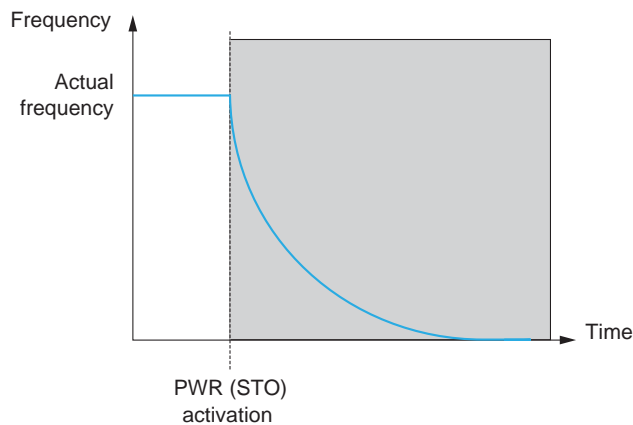

PWR (STO) Normative reference

The normative definition of PWR (STO) function is in §4.2.2.2 of the IEC 61800-5-2 (on the 07/2007 version):

"Power, that can cause rotation (or motion in the case of a linear motor), is not applied to the motor. The PDS(SR)(Power Drive System with safety-related functions) will not provide energy to the motor which can generate torque (or force in the case of a linear motor)."

NOTE 1 This safety function corresponds to an uncontrolled stop in accordance with stop category 0 of IEC 60204-1.

NOTE 2 This safety function may be used where power removal is required to help prevent an unexpected start-up.

NOTE 3 In circumstances where external influences (for example, falling of suspended loads) are present, additional measures (for example, mechanical brakes) may be necessary to help prevent any hazard.

NOTE 4 Electronic means and contactors are not adequate for protection against electric shock, and additional measures for isolation may be necessary."

Safety function (SF) level required for PWR (STO) function

| Configuration | SIL (Safety Integrity Level) according to IEC 61-508 | PL (Performance Level) according to ISO-13849 |
|--------------------------------|--|---|
| PWR (STO) with Preventa module | SIL 2 | PL "d" |

The Preventa module is required for the machine environment because:

- For the machine environment (IEC60204-1 & Machine Directive), reset shall not initiate a restart in any cases. One of the most stringent case is when PWR (STO) is activated, then the power supply is switch off. In this case, if PWR (STO) is deactivated during the loss of supply, the motor do not have to restart automatically. The Preventa module can help prevent a spurious restart in the previous condition. So the Preventa module is mandatory for machine applications.
- E_stop of several BDM in a PDS: the Preventa module has some safety outputs for application which requires one or several safety outputs.

For other environments, the Preventa module is not required, except if the application requires it: System fallback position.

Incompatibility with safety functions



4

What's in this Chapter?

This chapter contains the following topics:

| Topic | Page |
|-------------|------|
| Limitations | 22 |

Limitations

Type of Motor

PWR (STO) can be used with synchronous and asynchronous motors.

Prerequisites for using safety functions

Some parameters have to be fulfilled for a proper operation:

- Motor size is adequate to the application and is not in the limit of its capacity
- Speed drive size has been properly chosen for the electrical mains, sequence, motor and application and it is not in the limit of their catalogued capacities.
- If required, the adequate options are used. Example: like dynamic brake resistor or motor inductor.
- The drive is properly setting up for the right speed loop and torque characteristics for the application; the speed profile of the reference is mastered by the drive control loop.

Allowed and unallowed application for safety function

Allowed application

Allowed sharp of stop after PWR (STO) request or freewheel stop

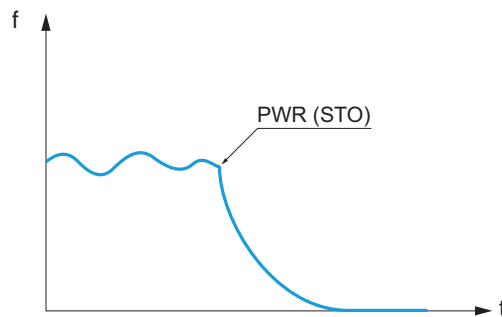

Unallowed application

Application with acceleration of the load after shut down of the drive or where there are long/permanent regenerative braking cycles are not allowed. Unallowed sharp of stop after PWR (STO) request or freewheel stop.

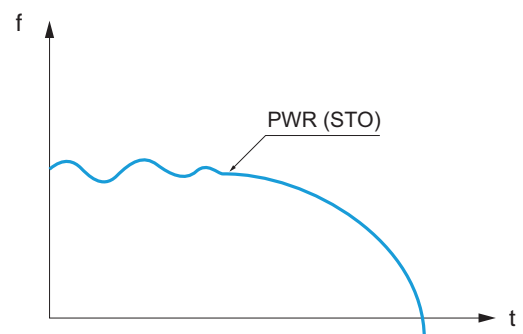
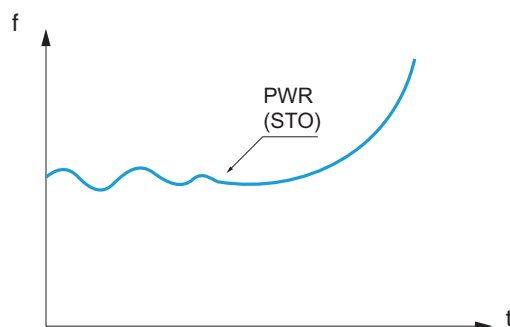

Examples: vertical conveyors, vertical hoist, lifts or winders.

Fault Inhibition

For some kind of detected fault, **[Fault inhibit assign.] (I n H)** can be requested to avoid the drive to stop when the fault occurred. The fault inhibition goal is not compatible with the safe function behavior.

When a safe function is activated, detected fault generated by the safe function **P r A** can't be inhibited.

Factory settings

If the drive is in safe mode and you activate the factory settings only non safety parameters will be downloaded in the drive. Safe parameters are not impacted by factory settings.

Safety monitoring



6

What's in this Chapter?

This chapter contains the following topics:

| Topic | Page |
|-------------------------------|------|
| Power Removal Safety Function | 26 |

Power Removal Safety Function

Description

When the dedicated Power Removal logical input (PWR) is activated, the output power bridge of the drive is locked by the Hardware in order to avoid any torque in the motor. The output power bridge of the drive is also locked by a redundant software and hardware channel.

When the Power Removal Function is active, the drive locks its output power bridge in order to avoid any torque in the motor.

When a fault is detected into the hardware of the Power Removal Safety Function, the drive trips and locks its output power bridge by the redundant hardware and software channel, even if the Power Removal Input is not activated.

If Power Removal is Active, then Power Bridge is locked by Software and Power Removal Active status (**P r A**) is activated and displayed.

If Power Removal is Active and Power Removal is Faulty, then the drive trips in **P r F** detected fault.

Technical data



7

What's in this Chapter?

This chapter contains the following topics:

| Topic | Page |
|-----------------------------|------|
| Electrical Data | 28 |
| Safety function capability | 29 |
| Two certified architectures | 31 |
| Process system SF - Case 1 | 32 |
| Process system SF - Case 2 | 33 |
| Process system SF - Case 3 | 35 |

Electrical Data

The Logic inputs and Logic outputs of the drive can be wired for logic type 1 or logic type 2.

| Logic Type | Active state |
|------------|--|
| 1 | Output draws current (Sink) Current flows to the input |
| 2 | Output supplies flows from the input Current Current (Source) |

Safe function only used in source mode, sink is not compatible with safe functions.
Signal inputs are protected against reverse polarity, outputs are short-circuit protected. The inputs and outputs are galvanically isolated.

Control connection diagrams

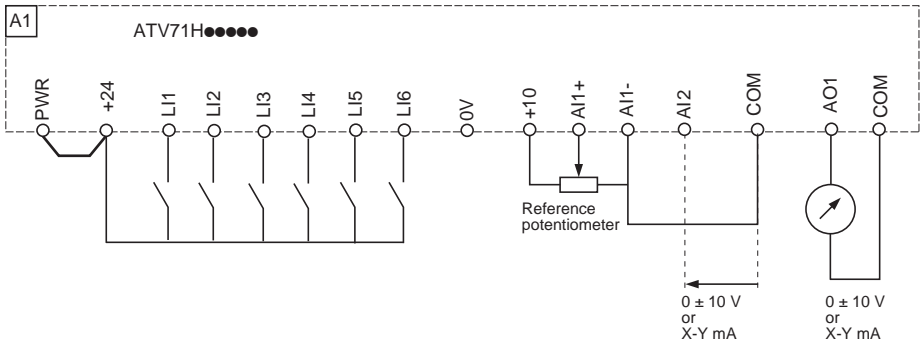

Logic input switch (SW1)

The logic input switch (SW1) is used to adapt the operation of the logic inputs to the technology of the programmable controller outputs.

- Set the switch to Source (factory setting) if using PLC outputs with PNP transistors.
- Set the switch to Sink Int or Sink Ext if using PLC outputs with NPN transistors.
- Switch SW1 set to "Source" position

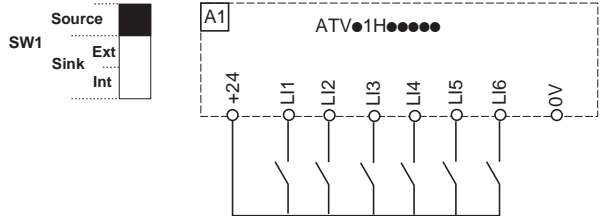

⚠ DANGER

UNINTENDED EQUIPMENT OPERATION

Prevent accidental grounding of logic inputs wired in "sink logic". Accidental grounding can result in unintended activation of drive functions.

Protect the signal conductors against damage that could result in unintentional conductor grounding.

Failure to follow these instructions will result in death or serious injury.

- Switch SW1 set to "Source" position and use of an external power supply for the LIs

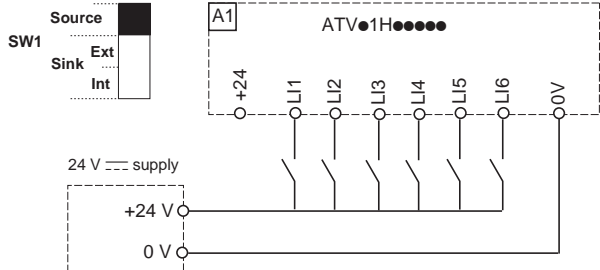

Safety function capability

Safety functions of PDS (SR) are part of a global system

If qualitative and quantitative objectives of safety set by the final application requires to make some adjustments to use the safety functions in a safe way, then the integrator of the BDM is responsible of these complementary evolutions (for example management of the mecanichal brake on the motor).

Also, the output information generated by the utilization of safety functions (default relay activation, relay of brake logic command, errors codes or information on the display, ...) aren't considering safety informations. Machine application

| Function | PWR (STO) |
|--------------------------------|---|
| Configuration | PWR (STO) with Preventa XPS AF or equivalent |
| Standard | |
| IEC 61800-5-2 / IEC 61508 / | SIL2 |
| IEC 62061 (1) | SIL2 CL |
| EN 954-1 (2) | Category 3 |
| ISO 13849-1 (3) | Category 3 PL "d" |
| IEC 60204-1 | Category stop 0 |

(1) Because the standard IEC 62061 is an integration standard, this standard distinguishes the global safety function (which is classify SIL2 for ATV61/71/LIFT according to diagrams Process system SF - Case 1, page 32 and Process system SF - Case 2, page 33) from components which constitute the safety function (which is classify SIL2 CL for ATV61/71/LIFT)

(2) According to table 6 of IEC 62061 (2005)

(3) According to table 4 of EN13849-1 (2008)

Process application

| Function | PWR (STO) |
|--------------------------------|------------------|
| Configuration | PWR (STO) |
| Standard | |
| IEC 61800-5-2 / IEC 61508 / | SIL2 |
| IEC 62061 (1) | SIL2 CL |

(1) Because the standard IEC 62061 is an integration standard, this standard distinguishes the global safety function (which is classify SIL2 for ATV61/71/LIFT according to diagrams Process system SF - Case 1, page 32 and Process system SF - Case 2, page 33) from components which constitute the safety function (which is classify SIL2 CL for ATV61/71/LIFT)

Input signals safety functions

| Input signals safety functions | Units | Value for PWR (STO) |
|-----------------------------------|------------|------------------------|
| Logic 0 (Ulow) | Vdc | < 2 |
| Logic 1 (Uhigh) | Vdc | > 17 |
| Impedance (24V) | kΩ | 1.5 |
| Debounce time | ms | < 1 |
| Response time of safety function | ms | < 10 |

Synthesis of the dependability study

| Standard | Input | size 2 - 5 | size 6 - 8 | size 9 - 10 | size 11 -15 | size 23 -24 |
|-----------------|-------------------|-----------------------|-----------------------|-----------------------|-----------------------|-----------------------|
| IEC61508 Ed.2 | SFF | 92% | 91% | 91% | 91% | 92 % |
| | PFH | 1 E-8 h ⁻¹ | 1 E-8 h ⁻¹ | 1 E-8 h ⁻¹ | 1 E-8 h ⁻¹ | 1 E-8 h ⁻¹ |
| | Type | B | B | B | B | B |
| | HFT | 1 | 1 | 1 | 1 | 1 |
| | DC avg | 70,40% | 68,30% | 71,20% | 69,70% | 69,70% |
| | SIL capability | 2 | 2 | 2 | 2 | 2 |
| IEC 62061 (1) | SIL CL capability | 2 | 2 | 2 | 2 | 2 |
| EN 954-1 (2) | Category | 3 | 3 | 3 | 3 | 3 |
| ISO 13849-1 (3) | PL | d | d | d | d | d |
| | Category | 3 | 3 | 3 | 3 | 3 |
| | MTTFd in years | 1800 | 1900 | 1750 | 1850 | 1850 |

(1) Because the standard IEC 62061 is an integration standard, this standard distinguishes the global safety function (which is classify SIL2 for ATV61/71/LIFT according to diagrams Process system SF - Case 1, page 32 and Process system SF - Case 2, page 33) from components which constitute the safety function (which is classify SIL2 CL for ATV61/71/LIFT)

(2) According to table 6 of IEC 62061 (2005)

(3) According to table 4 of EN13849-1 (2008)

Preventive annual activation of the safety function is recommended. However the safety levels are reached with lower margins without annual activation.

Note: The table above is not sufficient to evaluate the PL of a PDS. The PL evaluation has to be done at the system level. The fitter or the integrator of the BDM has to do the system PL evaluation by including sensors data with numbers from the table above.

Drive sizes table

Please refer to the tables, page 37 for correspondence between product sizes and references.

EN ISO 13849 standard

This European Standard specifies the validation process, including both analysis and testing, for the safety functions and categories for the safety-related parts of control systems. Descriptions of the safety functions and the requirements for the categories are given in EN 954-1 (ISO 13849-1) which deals the general principles for design. Some requirements for validation are general and some are specific to the technology used. EN ISO 13849-2 also specifies the conditions under which the validation by testing of the safety-related parts of control systems should be carried out.

Isolation distances and interval are sized at least according to IEC 60264-1. See the following table

Printed circuits boards/assemblies

| Fault considered | Fault exclusion | Remarks |
|--|---|--|
| Short-circuit between two adjacent tracks/pads | Short-circuits between adjacent conductors in accordance with remarks 1) to 3). | The base material used is according to IEC 60249 and the creep-age distances and clearances are dimensioned at least to IEC 60664-1: 1992 with at least pollution/installation category III. The printed side(s) of the assembled board is covered with an ageing-resistant varnish or a protective layer covering all conductor paths in accordance with IEC 60664-3 All enclosures of the safety-related parts of the control system, including those mounted remotely, should provide a degree of protection of at least IP54 [see EN 60529 (IEC 60529)], when mounted as specified. |
| Open-circuit of any track | None | - |

Two certified architectures

NOTE: For the certification relative to functional aspects, only the PDS(SR) (Power Drive System with safety-related functions) will be in consideration, and not the complete system in which fits into to help to ensure the functional safety of a machine or a system/process.

Here are the two architectures certified:

- Process system SF - Case 1, page [32](#)
- Process system SF - Case 2, page [33](#)
- Process system SF - Case 3, page [35](#)

Safety functions of PDS (SR) (Power Drive System with safety-related functions) are part of a global system.

If qualitative and quantitative objectives of safety set by the final application require to make some adjustments to use the safety functions in a safe way, then the integrator of the BDM (background debug module) is responsible of these complementary evolutions (for example management of the mechanical brake on the motor).

Also, the output information generated by the utilization of safety functions (default relay activation, relay of brake logic command, errors codes or information on the display, ...) are not considering safety informations.

Process system SF - Case 1

Connection diagrams conforming to standards EN 954-1 category 3, ISO 13849-1 and IEC/EN 61508 capacity SIL2, stopping category 0 in accordance with standard IEC/EN 60204-1

This connection diagram is suitable for use with machines with a short freewheel stop time (machines with low inertia or high resistive torque).

When the stop request is activated, the motor power supply is cut immediately and it stops in accordance with category 0 of standard IEC/EN 60204-1.

Note: This diagram must be used for hoisting applications if a mechanical brake is controlled by an ATV71.

A contact on the Preventa XPS AC module must be inserted in the brake control circuit to engage it safely when the Power Removal safety function is activated.

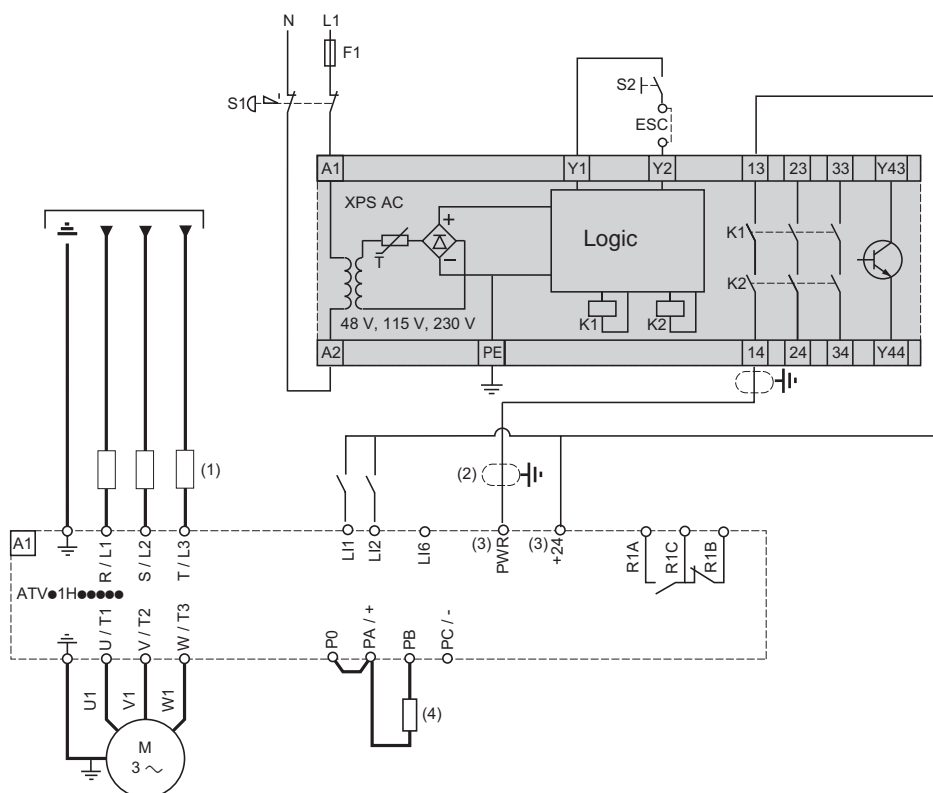

- (1) Line choke (if used)
 (2) Standardized coaxial cable, type RG174/U according to MIL-C17 or KX3B according to NF C 93-550, external diameter 2.54 mm / 0.09 in., maximum length 15 m / 49.21 ft. The cable shielding must be earthed
 (3) Use cable ends DZ5CE020 (yellow) on wires connected to PWR and +24 inputs
 (4) Braking resistor (if used)

- Standard EN 954-1 category 3 and ISO 13849-1 require the use of a dual-contact stop button (S1).
- S1 is used to activate the Power Removal safety function.
- S2 is used to initialize the Preventa module when powering up or after an emergency stop. ESC enables the use of other initialization conditions for the module.
- One Preventa module can be used for the Power Removal safety function on several ATV61/71/LIFT drives.
- A logic output on the Preventa module can be used to indicate reliably that the drive is operating in safe conditions.

Note:

For preventive maintenance, the Power Removal function must be activated at least once a year. The drive power supply must be turned off and then on again before carrying out this preventive maintenance. The drive logic output signals cannot be considered as safety-type signals. Install interference suppressors on all inductive circuits near the drive or coupled to the same circuit (relays, contactors, solenoid valves, etc).

Choice of associated components:

Please refer to the catalog.

Process system SF - Case 2

Connection diagram conforming to standards EN 954-1 category 3, ISO 13849-1 and IEC/EN 61508 capacity SIL2, stopping category 1 in accordance with standard IEC/EN 60204-1

This connection diagram is suitable for use with machines with a long freewheel stop time (machines with high inertia or low resistive torque).

▲WARNING

LOSS OF CONTROL

This diagram must not be used for hoisting applications. Use process system SF - Case 1.

Failure to follow these instructions can result in death, serious injury, or equipment damage.

When the stop request is activated, deceleration of the motor, controlled by the drive, is requested first. Then, after a time delay corresponding to the deceleration time, the Power Removal safety function is activated.

Example:

- 2-wire control
- L1 assigned to forward
- L12 assigned to reverse

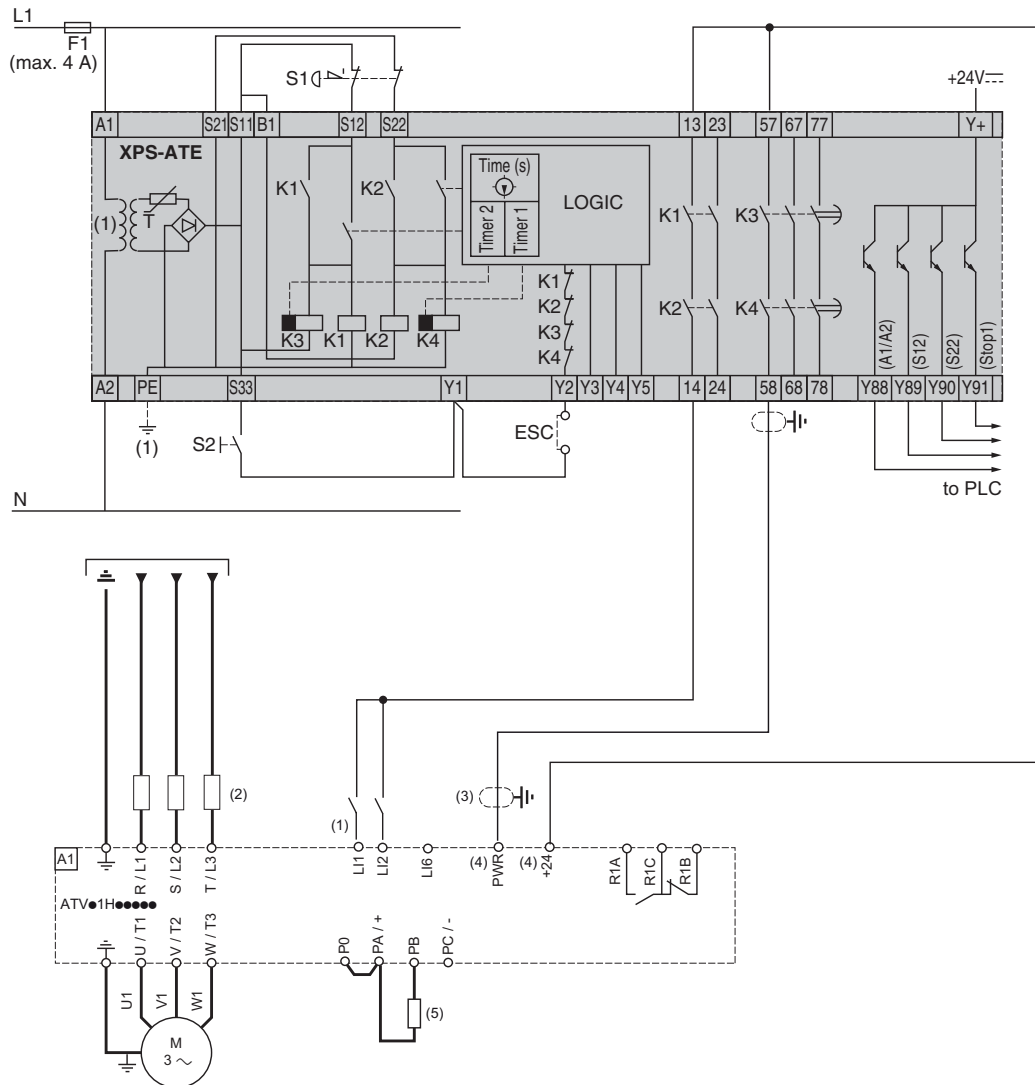

(1) In this example, the logic inputs LI● are wired as "Source" but can be wired as "Sink Int" or "Sink Ext".

(2) Line choke (if used)

(3) Standardized coaxial cable, type RG174/U according to MIL-C17 or KX3B according to NF C 93-550, external diameter 2.54 mm / 0.09 in., maximum length 15 m / 49.21 ft. The cable shielding must be earthed.

(4) Use cable ends DZ5CE020 (yellow) on wires connected to PWR and +24 inputs

(5) Braking resistor (if used)

- Standard EN 954-1 category 3 and ISO 13849-1 require the use of a dual-contact stop button (S1).
- S1 is used to activate the Power Removal safety function.
- S2 is used to initialize the Preventa module when powering up or after an emergency stop. ESC enables the use of other initialization conditions for the module.
- One Preventa module can be used for the Power Removal safety function on several ATV61/71/LIFT drives. In this case the time delay must be set to the longest stopping time.
- A logic output on the Preventa module can be used to indicate reliably that the drive is operating in safe conditions.

Note:

For preventive maintenance, the Power Removal function must be activated at least once a year. The drive power supply must be turned off and then on again before carrying out this preventive maintenance. The drive logic output signals cannot be considered as safety-type signals. Install interference suppressors on all inductive circuits near the drive or coupled to the same circuit (relays, contactors, solenoid valves, etc).

Choice of associated components:

Please refer to the catalog.

Process system SF - Case 3

Multi-drive conforming to standards EN 954-1 category 3, ISO 13849-1 and IEC/EN 61508 capacity SIL2, stopping category 1 in accordance with standard IEC/EN 60204-1

This connection diagram is suitable for use with machines with a long freewheel stop time (machines with high inertia or low resistive torque)..

⚠ WARNING

LOSS OF CONTROL

This diagram must not be used for hoisting applications. Use process system SF - Case 1.

Failure to follow these instructions can result in death, serious injury, or equipment damage.

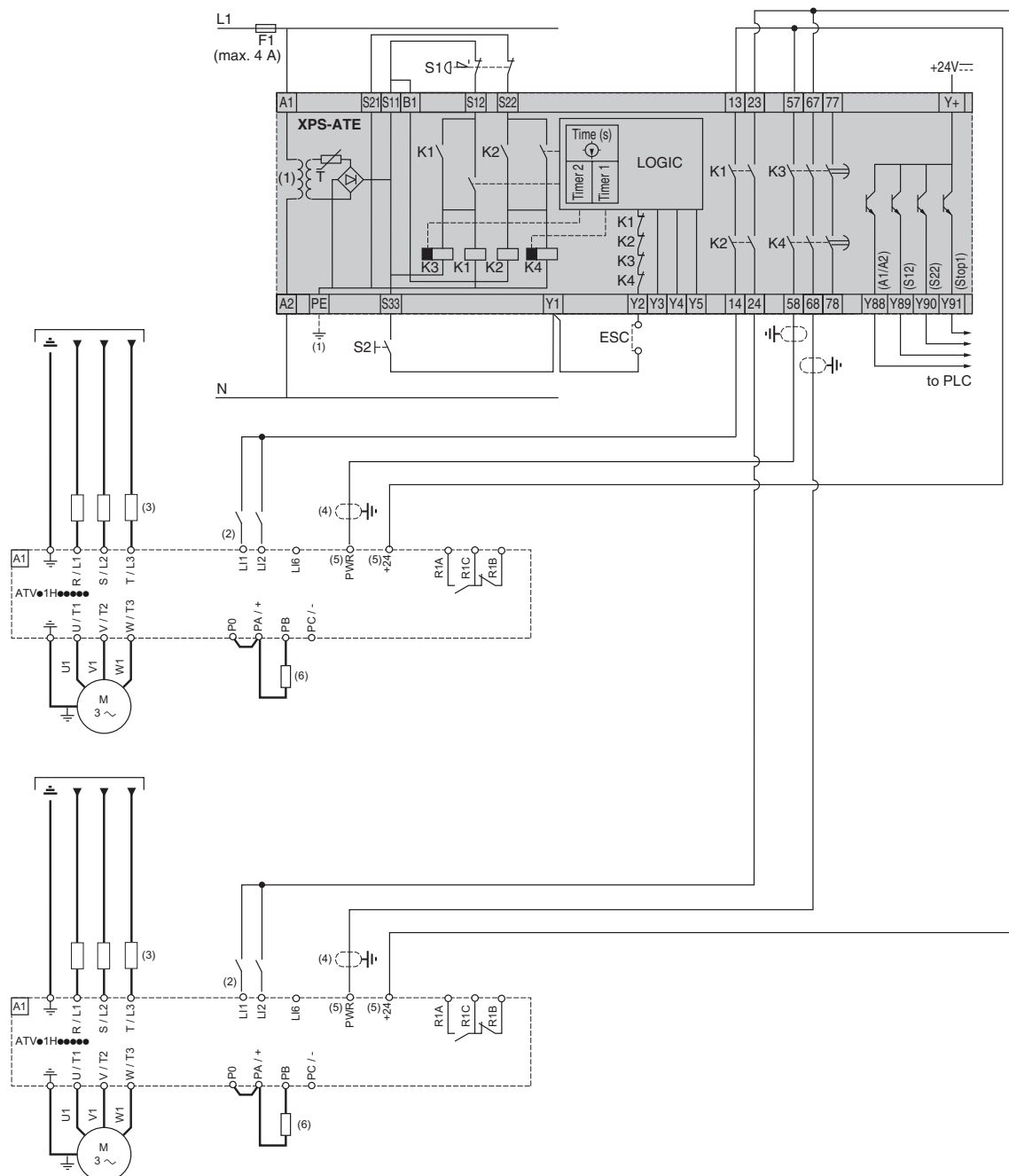

- (1) 115/230 V ~ only.
- (2) In this example, the logic inputs L10 are wired as "Source" but can be wired as "Sink Int" or "Sink Ext".
- (3) Line choke (if used)
- (4) Standardized coaxial cable, type RG174/U according to MIL-C17 or KX3B according to NF C 93-550, external diameter 2.54 mm / 0.09 in., maximum length 15 m / 49.21 ft. The cable shielding must be earthed.

- (5) Use cable ends DZ5CE020 (yellow) on wires connected to PWR and +24 inputs.
- (6) Braking resistor (if used)

When the stop request is activated, deceleration of the motor, controlled by the drive, is requested first. Then, after a time delay corresponding to the deceleration time, the Power Removal safety function is activated.

Example:

- 2-wire control
 - LI1 assigned to forward.
 - LI2 assigned to reverse.
-
- Standard EN 954-1 category 3 and ISO 13849-1 require the use of a dual-contact stop button (S1).
 - S1 is used to activate the Power Removal safety function.
 - S2 is used to initialize the Preventa module when powering up or after an emergency stop. ESC enables the use of other initialization conditions for the module.
 - One Preventa module can be used for the Power Removal safety function on several ATV61/71/LIFT drives. In this case the time delay must be set to the longest stopping time.

A Logic output on the Preventa module can be used to indicate reliably that the drive is operating in safe conditions.

Note: For preventive maintenance, the Power Removal function must be activated at least once a year. The drive power supply must be turned off and then on again before carrying out this preventive maintenance. The drive logic output signals cannot be considered as safety-type signals.

Install interference suppressors on all inductive circuits near the drive or coupled to the same circuit (relays, contactors, solenoid, valves, etc).

Choice of associated components:

Please refer to the catalog.

Appendix



8

What's in this Chapter?

This chapter contains the following topics:

| Topic | Page |
|---------------------|------|
| ATV61 Product sizes | 38 |
| ATV71 Product sizes | 42 |

ATV61 Product sizes

Correspondence table

This table allows making the correspondence between the size and the reference of the drive.

| Power Supply Voltage | Reference | Size 2 | Size 3 | Size 4 | Size 5 (5A – 5B) | Size 6 | Size 7 (7A – 7B) | Size 8 | Size 9 | Size 10 | Size 11 | Size 12 | Size 13 | Size 14 | Size 15 | |
|----------------------|--------------|--------|--------|--------|---------------------|--------|---------------------|--------|--------|---------|---------|---------|---------|---------|---------|--|
| 200 – 240 V | ATV61H075M3 | ● | | | | | | | | | | | | | | |
| | ATV61HU15M3 | ● | | | | | | | | | | | | | | |
| | ATV61HU22M3 | | ● | | | | | | | | | | | | | |
| | ATV61HU30M3 | | ● | | | | | | | | | | | | | |
| | ATV61HU40M3 | | ● | | | | | | | | | | | | | |
| | ATV61HU55M3 | | | ● | | | | | | | | | | | | |
| | ATV61HU75M3 | | | | ● | | | | | | | | | | | |
| | ATV61HD11M3X | | | | ● | | | | | | | | | | | |
| | ATV61HD15M3X | | | | ● | | | | | | | | | | | |
| | ATV61HD18M3X | | | | | ● | | | | | | | | | | |
| | ATV61HD22M3X | | | | | | ● | | | | | | | | | |
| | ATV61HD30M3X | | | | | | | ● | | | | | | | | |
| | ATV61HD37M3X | | | | | | | ● | | | | | | | | |
| | ATV61HD45M3X | | | | | | | ● | | | | | | | | |
| | ATV61HD55M3X | | | | | | | | ● | | | | | | | |
| | ATV61HD75M3X | | | | | | | | | ● | | | | | | |
| | ATV61HD90M3X | | | | | | | | | | ● | | | | | |

| Power Supply Voltage | Reference | Size 2 | Size 3 | Size 4 | Size 5 (5A – 5B) | Size 6 | Size 7 (7A – 7B) | Size 8 | Size 9 | Size 10 | Size 11 | Size 12 | Size 13 | Size 14 | Size 15 | |
|----------------------|-------------|--------|--------|--------|------------------|--------|------------------|--------|--------|---------|---------|---------|---------|---------|---------|---|
| 380 – 480 V | ATV61H075N4 | ● | | | | | | | | | | | | | | |
| | ATV61HU15N4 | ● | | | | | | | | | | | | | | |
| | ATV61HU22N4 | ● | | | | | | | | | | | | | | |
| | ATV61HU30N4 | | ● | | | | | | | | | | | | | |
| | ATV61HU40N4 | | ● | | | | | | | | | | | | | |
| | ATV61HU55N4 | | | ● | | | | | | | | | | | | |
| | ATV61HU75N4 | | | ● | | | | | | | | | | | | |
| | ATV61HD11N4 | | | | ● | | | | | | | | | | | |
| | ATV61HD15N4 | | | | ● | | | | | | | | | | | |
| | ATV61HD18N4 | | | | ● | | | | | | | | | | | |
| | ATV61HD22N4 | | | | | | ● | | | | | | | | | |
| | ATV61HD30N4 | | | | | | | ● | | | | | | | | |
| | ATV61HD37N4 | | | | | | | ● | | | | | | | | |
| | ATV61HD45N4 | | | | | | | | ● | | | | | | | |
| | ATV61HD55N4 | | | | | | | | ● | | | | | | | |
| | ATV61HD75N4 | | | | | | | | ● | | | | | | | |
| | ATV61HD90N4 | | | | | | | | | ● | | | | | | |
| | ATV61HC11N4 | | | | | | | | | ● | | | | | | |
| | ATV61HC13N4 | | | | | | | | | | ● | | | | | |
| | ATV61HC16N4 | | | | | | | | | | | ● | | | | |
| | ATV61QC11N4 | | | | | | | | | | | ● | | | | |
| | ATV61QC13N4 | | | | | | | | | | | ● | | | | |
| | ATV61QC16N4 | | | | | | | | | | | ● | | | | |
| | ATV61HC20N4 | | | | | | | | | | | | ● | | | |
| | ATV61HC22N4 | | | | | | | | | | | | ● | | | |
| | ATV61HC25N4 | | | | | | | | | | | | | ● | | |
| | ATV61HC28N4 | | | | | | | | | | | | | ● | | |
| | ATV61HC31N4 | | | | | | | | | | | | | ● | | |
| | ATV61QC20N4 | | | | | | | | | | | | | ● | | |
| | ATV61QC25N4 | | | | | | | | | | | | | ● | | |
| | ATV61QC31N4 | | | | | | | | | | | | | ● | | |
| | ATV61HC40N4 | | | | | | | | | | | | | | ● | |
| | ATV61HC50N4 | | | | | | | | | | | | | | ● | |
| | ATV61HC63N4 | | | | | | | | | | | | | | | ● |
| ATV61QC40N4 | | | | | | | | | | | | | | | ● | |
| ATV61QC50N4 | | | | | | | | | | | | | | | ● | |
| ATV61QC63N4 | | | | | | | | | | | | | | | ● | |

| Power Supply Voltage | Reference | Size 2 | Size 3 | Size 4 | Size 5 (5A – 5B) | Size 6 | Size 7 (7A – 7B) | Size 8 | Size 9 | Size 10 | Size 11 | Size 12 | Size 13 | Size 14 | Size 15 | |
|----------------------|------------|--------|--------|--------|---------------------|--------|---------------------|--------|--------|---------|---------|---------|---------|---------|---------|---|
| 500 – 690 V | ATV61HU30Y | | | | | • | | | | | | | | | | |
| | ATV61HU40Y | | | | | • | | | | | | | | | | |
| | ATV61HU55Y | | | | | • | | | | | | | | | | |
| | ATV61HU75Y | | | | | • | | | | | | | | | | |
| | ATV61HD11Y | | | | | • | | | | | | | | | | |
| | ATV61HD15Y | | | | | • | | | | | | | | | | |
| | ATV61HD18Y | | | | | • | | | | | | | | | | |
| | ATV61HD22Y | | | | | • | | | | | | | | | | |
| | ATV61HD30Y | | | | | • | | | | | | | | | | |
| | ATV61HD37Y | | | | | | | | • | | | | | | | |
| | ATV61HD45Y | | | | | | | | • | | | | | | | |
| | ATV61HD55Y | | | | | | | | • | | | | | | | |
| | ATV61HD75Y | | | | | | | | • | | | | | | | |
| | ATV61HD90Y | | | | | | | | • | | | | | | | |
| | ATV61HC11Y | | | | | | | | | | | • | | | | |
| | ATV61HC13Y | | | | | | | | | | | • | | | | |
| | ATV61HC16Y | | | | | | | | | | | • | | | | |
| | ATV61HC20Y | | | | | | | | | | | • | | | | |
| | ATV61QC13Y | | | | | | | | | | | • | | | | |
| | ATV61QC16Y | | | | | | | | | | | • | | | | |
| | ATV61QC20Y | | | | | | | | | | | • | | | | |
| | ATV61HC25Y | | | | | | | | | | | | | • | | |
| | ATV61HC31Y | | | | | | | | | | | | | • | | |
| | ATV61HC40Y | | | | | | | | | | | | | • | | |
| | ATV61QC25Y | | | | | | | | | | | | | • | | |
| | ATV61QC31Y | | | | | | | | | | | | | • | | |
| | ATV61QC40Y | | | | | | | | | | | | | • | | |
| | ATV61HC50Y | | | | | | | | | | | | | | | • |
| | ATV61HC63Y | | | | | | | | | | | | | | | • |
| | ATV61HC80Y | | | | | | | | | | | | | | | • |
| | ATV61QC50Y | | | | | | | | | | | | | | | • |
| | ATV61QC63Y | | | | | | | | | | | | | | | • |
| ATV61QC80Y | | | | | | | | | | | | | | | • | |

| Power Supply Voltage | Reference | Size 23 | Size 24 |
|----------------------|----------------|---------|---------|
| 380 – 415 V | ATV61EX●●C63N4 | ● | |
| | ATV61EX●●C71N4 | ● | |
| | ATV61EM●●C63N4 | ● | |
| | ATV61EM●●C71N4 | ● | |
| | ATV61EM●●C90N4 | | ● |
| | ATV61EM●●M11N4 | | ● |
| | ATV61EM●●M13N4 | | ● |
| | ATV61EM●●M14N4 | | ● |
| | ATV61EX●●C90N4 | | ● |
| | ATV61EX●●M11N4 | | ● |
| | ATV61EX●●M13N4 | | ● |
| | ATV61EX●●M14N4 | | ● |
| 500 V | ATV61EX●●C63N | ● | |
| | ATV61EX●●C71N | ● | |
| | ATV61EX●●C90N | ● | |
| | ATV61EX●●M11N | | ● |
| | ATV61EX●●M13N | | ● |
| | ATV61EX●●M15N | | ● |
| | ATV61EX●●M18N | | ● |
| 690 V | ATV61EX●●C80Y | ● | |
| | ATV61EX●●M10Y | ● | |
| | ATV61EX●●M12Y | ● | |
| | ATV61EM●●C80Y | ● | |
| | ATV61EM●●M10Y | ● | |
| | ATV61EM●●M12Y | ● | |
| | ATV61EX●●M15Y | | ● |
| | ATV61EX●●M18Y | | ● |
| | ATV61EX●●M21Y | | ● |
| | ATV61EX●●M24Y | | ● |
| | ATV61EM●●M15Y | | ● |
| | ATV61EM●●M18Y | | ● |
| | ATV61EM●●M21Y | | ● |
| | ATV61EM●●M24Y | | ● |

ATV71 Product sizes

Correspondence table

This table allows making the correspondence between the size and the reference of the drive.

| Power Supply Voltage | Reference | Size 2 | Size 3 | Size 4 | Size 5 (5A – 5B) | Size 6 | Size 7 (7A – 7B) | Size 8 | Size 9 | Size 10 | Size 11 | Size 12 | Size 13 | Size 14 | Size 15 | |
|----------------------|--------------|--------|--------|--------|------------------|--------|------------------|--------|--------|---------|---------|---------|---------|---------|---------|---|
| 200 – 240 V | ATV71H037M3 | ● | | | | | | | | | | | | | | |
| | ATV71H075M3 | ● | | | | | | | | | | | | | | |
| | ATV71HU15M3 | ● | | | | | | | | | | | | | | |
| | ATV71HU22M3 | | ● | | | | | | | | | | | | | |
| | ATV71HU30M3 | | ● | | | | | | | | | | | | | |
| | ATV71HU40M3 | | ● | | | | | | | | | | | | | |
| | ATV71HU55M3 | | | ● | | | | | | | | | | | | |
| | ATV71HU75M3 | | | | ● | | | | | | | | | | | |
| | ATV71HD11M3X | | | | | ● | | | | | | | | | | |
| | ATV71HD15M3X | | | | | ● | | | | | | | | | | |
| | ATV71HD18M3X | | | | | | ● | | | | | | | | | |
| | ATV71HD22M3X | | | | | | ● | | | | | | | | | |
| | ATV71HD30M3X | | | | | | | ● | | | | | | | | |
| | ATV71HD37M3X | | | | | | | ● | | | | | | | | |
| | ATV71HD45M3X | | | | | | | ● | | | | | | | | |
| | ATV71HD55M3X | | | | | | | | ● | | | | | | | |
| | ATV71HD75M3X | | | | | | | | | ● | | | | | | |
| 380 – 480 V | ATV71H075N4 | ● | | | | | | | | | | | | | | |
| | ATV71HU15N4 | ● | | | | | | | | | | | | | | |
| | ATV71HU22N4 | ● | | | | | | | | | | | | | | |
| | ATV71HU30N4 | | ● | | | | | | | | | | | | | |
| | ATV71HU40N4 | | ● | | | | | | | | | | | | | |
| | ATV71HU55N4 | | | ● | | | | | | | | | | | | |
| | ATV71HU75N4 | | | ● | | | | | | | | | | | | |
| | ATV71HD11N4 | | | | ● | | | | | | | | | | | |
| | ATV71HD15N4 | | | | ● | | | | | | | | | | | |
| | ATV71HD18N4 | | | | ● | | | | | | | | | | | |
| | ATV71HD22N4 | | | | | ● | | | | | | | | | | |
| | ATV71HD30N4 | | | | | | ● | | | | | | | | | |
| | ATV71HD37N4 | | | | | | | ● | | | | | | | | |
| | ATV71HD45N4 | | | | | | | | ● | | | | | | | |
| | ATV71HD55N4 | | | | | | | | ● | | | | | | | |
| | ATV71HD75N4 | | | | | | | | ● | | | | | | | |
| | ATV71HD90N4 | | | | | | | | | ● | | | | | | |
| | ATV71HC11N4 | | | | | | | | | | ● | | | | | |
| | ATV71HC13N4 | | | | | | | | | | | ● | | | | |
| | ATV71QD90N4 | | | | | | | | | | | ● | | | | |
| | ATV71QC11N4 | | | | | | | | | | | ● | | | | |
| | ATV71QC13N4 | | | | | | | | | | | ● | | | | |
| | ATV71HC16N4 | | | | | | | | | | | | ● | | | |
| | ATV71HC20N4 | | | | | | | | | | | | | ● | | |
| | ATV71HC25N4 | | | | | | | | | | | | | | ● | |
| | ATV71HC28N4 | | | | | | | | | | | | | | ● | |
| | ATV71QC16N4 | | | | | | | | | | | | | | ● | |
| | ATV71QC20N4 | | | | | | | | | | | | | | ● | |
| | ATV71QC25N4 | | | | | | | | | | | | | | ● | |
| | ATV71HC31N4 | | | | | | | | | | | | | | | ● |
| | ATV71HC40N4 | | | | | | | | | | | | | | | ● |
| | ATV71HC50N4 | | | | | | | | | | | | | | | ● |
| | ATV71QC31N4 | | | | | | | | | | | | | | | ● |
| ATV71QC40N4 | | | | | | | | | | | | | | | ● | |
| ATV71QC50N4 | | | | | | | | | | | | | | | ● | |

| Power Supply Voltage | Reference | Size 2 | Size 3 | Size 4 | Size 5 (5A – 5B) | Size 6 | Size 7 (7A – 7B) | Size 8 | Size 9 | Size 10 | Size 11 | Size 12 | Size 13 | Size 14 | Size 15 |
|----------------------|------------|--------|--------|--------|---------------------|--------|---------------------|--------|--------|---------|---------|---------|---------|---------|---------|
| 500 – 690 V | ATV71HU22Y | | | | | • | | | | | | | | | |
| | ATV71HU30Y | | | | | • | | | | | | | | | |
| | ATV71HU40Y | | | | | • | | | | | | | | | |
| | ATV71HU55Y | | | | | • | | | | | | | | | |
| | ATV71HU75Y | | | | | • | | | | | | | | | |
| | ATV71HD11Y | | | | | • | | | | | | | | | |
| | ATV71HD15Y | | | | | • | | | | | | | | | |
| | ATV71HD18Y | | | | | • | | | | | | | | | |
| | ATV71HD22Y | | | | | • | | | | | | | | | |
| | ATV71HD30Y | | | | | • | | | | | | | | | |
| | ATV71HD37Y | | | | | | | | • | | | | | | |
| | ATV71HD45Y | | | | | | | | • | | | | | | |
| | ATV71HD55Y | | | | | | | | • | | | | | | |
| | ATV71HD75Y | | | | | | | | • | | | | | | |
| | ATV71HD90Y | | | | | | | | • | | | | | | |
| | ATV71HC11Y | | | | | | | | | | | • | | | |
| | ATV71HC13Y | | | | | | | | | | | • | | | |
| | ATV71HC16Y | | | | | | | | | | | • | | | |
| | ATV71QC11Y | | | | | | | | | | | • | | | |
| | ATV71QC13Y | | | | | | | | | | | • | | | |
| | ATV71QC16Y | | | | | | | | | | | • | | | |
| | ATV71HC20Y | | | | | | | | | | | | | • | |
| | ATV71HC25Y | | | | | | | | | | | | | • | |
| | ATV71HC31Y | | | | | | | | | | | | | • | |
| | ATV71QC20Y | | | | | | | | | | | | | • | |
| | ATV71QC25Y | | | | | | | | | | | | | • | |
| | ATV71QC31Y | | | | | | | | | | | | | • | |
| | ATV71HC40Y | | | | | | | | | | | | | | • |
| | ATV71HC50Y | | | | | | | | | | | | | | • |
| | ATV71HC63Y | | | | | | | | | | | | | | • |
| | ATV71QC40Y | | | | | | | | | | | | | | • |
| | ATV71QC50Y | | | | | | | | | | | | | | • |
| ATV71QC63Y | | | | | | | | | | | | | | • | |

| Power Supply Voltage | Reference | Size 23 | Size 24 |
|----------------------|----------------|---------|---------|
| 380 – 415 V | ATV71EX●●C50N4 | ● | |
| | ATV71EX●●C63N4 | ● | |
| | ATV71EM●●C63N4 | ● | |
| | ATV71EX●●C71N4 | | ● |
| | ATV71EX●●C90N4 | | ● |
| | ATV71EX●●M11N4 | | ● |
| | ATV71EX●●M13N4 | | ● |
| | ATV71EM●●C71N4 | | ● |
| | ATV71EM●●C90N4 | | ● |
| | ATV71EM●●M11N4 | | ● |
| ATV71EM●●M13N4 | | ● | |
| 500 V | ATV71EX●●C50N | ● | |
| | ATV71EX●●C63N | ● | |
| | ATV71EX●●C80N | ● | |
| | ATV71EX●●C90N | | ● |
| | ATV71EX●●M11N | | ● |
| | ATV71EX●●M13N | | ● |
| | ATV71EX●●M15N | | ● |
| 690 V | ATV71EX●●C63Y | ● | |
| | ATV71EX●●C80Y | ● | |
| | ATV71EX●●M10Y | ● | |
| | ATV71EM●●C63Y | ● | |
| | ATV71EM●●C80Y | ● | |
| | ATV71EM●●M10Y | ● | |
| | ATV71EX●●M12Y | | ● |
| | ATV71EX●●M15Y | | ● |
| | ATV71EX●●M18Y | | ● |
| | ATV71EX●●M20Y | | ● |
| | ATV71EM●●M12Y | | ● |
| | ATV71EM●●M15Y | | ● |
| | ATV71EM●●M18Y | | ● |
| ATV71EM●●M20Y | | ● | |

